

DESAIN ARSITEKTUR V

MIXED USE BUILDING

TEMA: BUILDING AS CAPITAL INVESTMENT

MODUL IV

DOSEN:

Ir. Octavianus H. A Rogi, ST, M.Si

Dr.Valeria Woy, ST.,MT

Prof. DR. Ir. Ar. Jefrey. I. Kindangen, DEA, IAI

Cynthia E.V Wuisang, ST,MUrbHabMgt, PhD







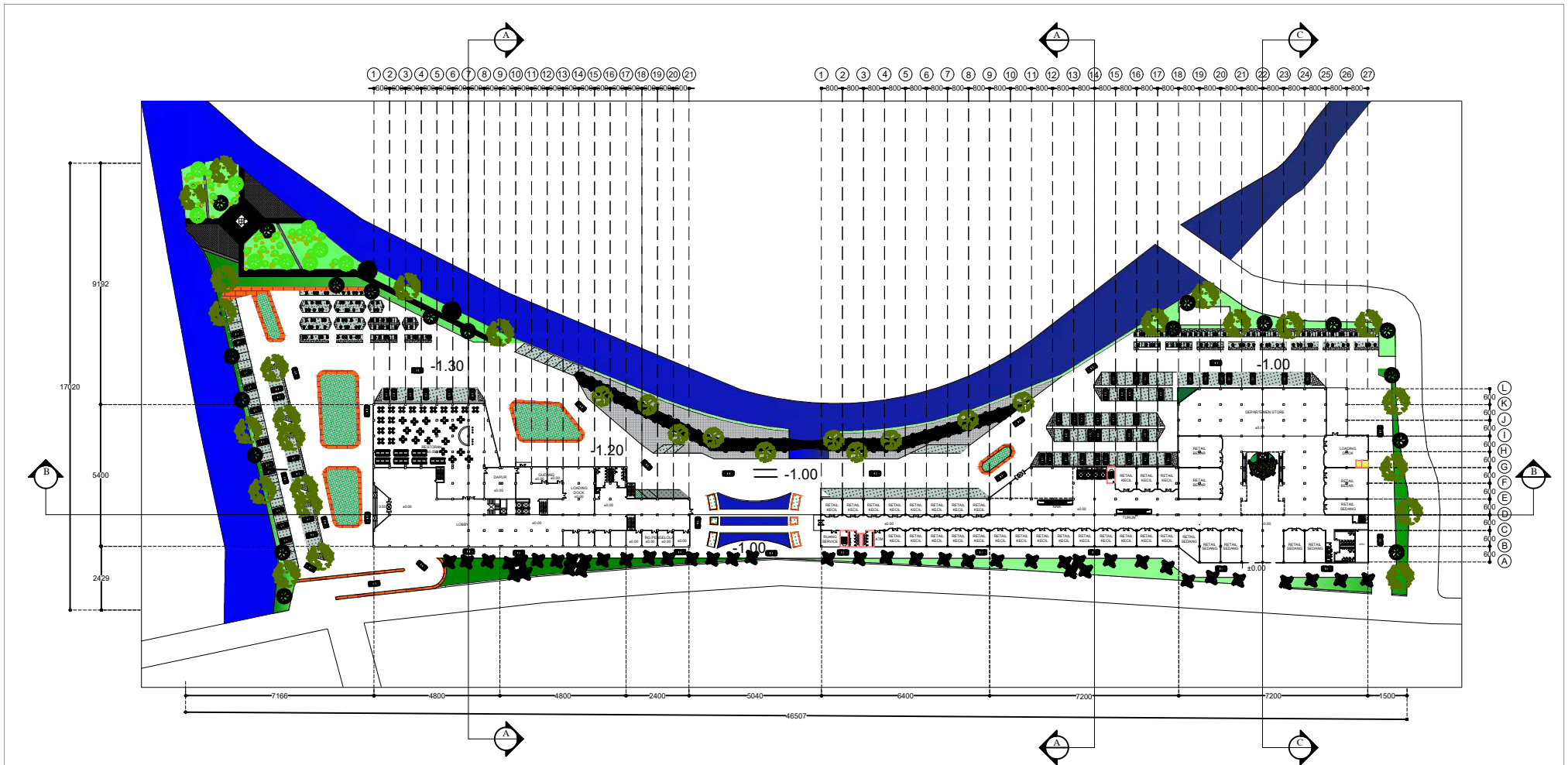

DR. Ir. Reny Syafrini, M.Ars

Rinda Wulan Kalangi

17021102011



KETERANGAN

-  Ketapang Kencana
-  Pohon Pucuk Merah
-  Pohon Palembang
-  Bunga Marigold
-  Pohon Flamboyan
-  Grass Block Pavers
-  Batu Tempel
-  Beton

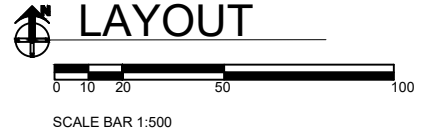

		MAHASISWA/NIM	DOSEN PEMBIMBING	DOSEN PEMBIMBING	KETERANGAN
 UNIVERSITAS SAM RATULANGI FAKULTAS TEKNIK JURUSAN ARSITEKTUR PRODI ARSITEKTUR	DESAIN ARSITEKTUR V	RINDA WULAN KALANGI (17021102011)	Ir. Octavianus H. A Rogi, ST, M.Si Dr.Valeria Woy, ST.,MT Prof. DR. Ir. Ar. Jefrev. I. Kindangan, DEA, IAI Cynthia E.V Wuisanq, ST,MurbHabMgt, PhD DR. Ir. Reny Syafrini, M.Ars	Ir. Octavianus H. A Rogi, ST, M.Si	
	JUDUL TUGAS				
	CAPITAL INVESTMENT MIXED USE				

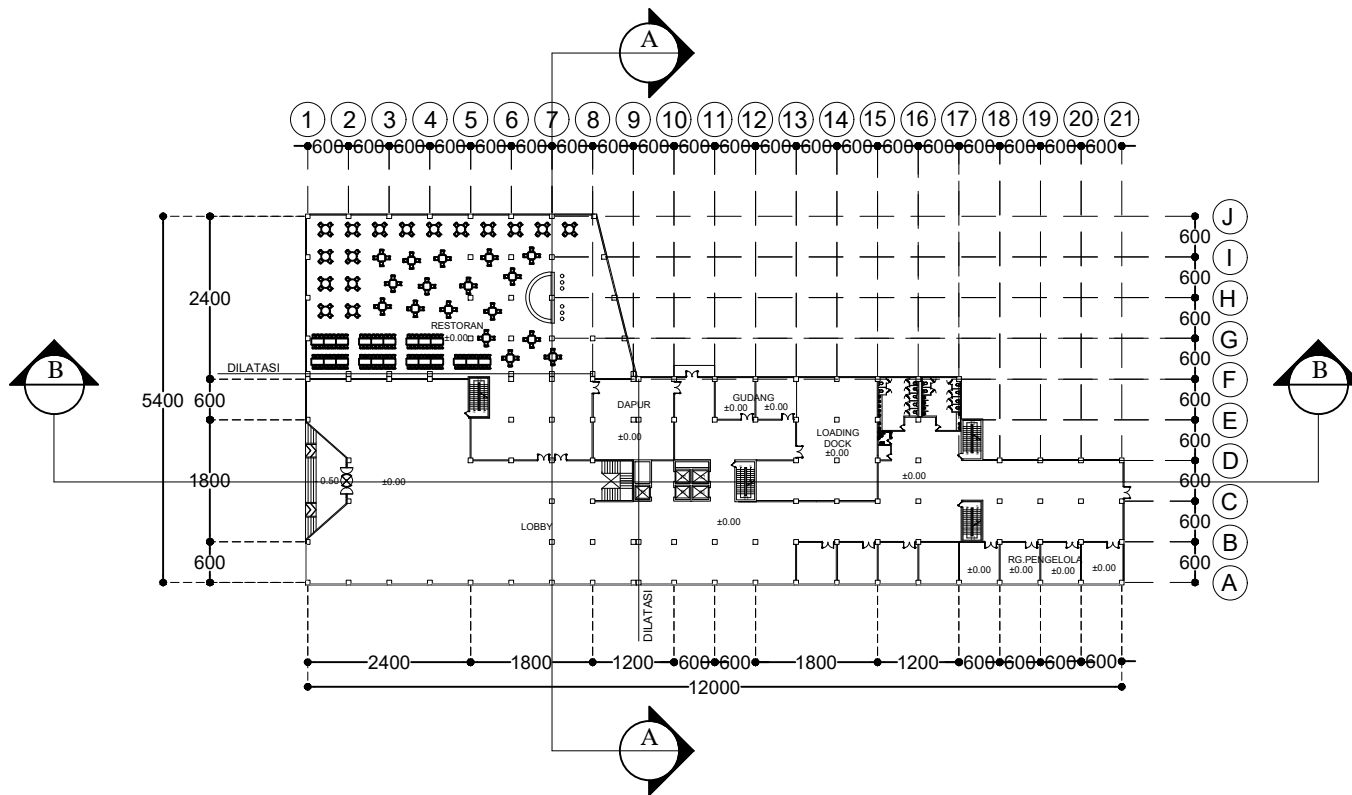

DENAH HOTEL LT DASAR



SCALE BAR 1:100

	MATA KULIAH	MAHASISWA/NIM	DOSEN PEMBIMBING	DOSEN PEMBIMBING	KETERANGAN
 <p>UNIVERSITAS SAM RATULANGI FAKULTAS TEKNIK JURUSAN ARSITEKTUR PRODI ARSITEKTUR</p>	DESAIN ARSITEKTUR V	<p>RINDA WULAN KALANGI (17021102011)</p>	<p>Ir. Octavianus H. A Rogi, ST, M.Si Dr.Valeria Woy, ST.,MT Prof. DR. Ir. Ar. Jefrev. I. Kindangen, DEA, IAI Cynthia E.V Wuisanq, ST,MurbHabMgt, PhD DR. Ir. Reny Syafrini, M.Ars</p>	<p>Ir. Octavianus H. A Rogi, ST, M.Si</p>	
	JUDUL TUGAS				
	CAPITAL INVESTMENT				
	MIXED USE				

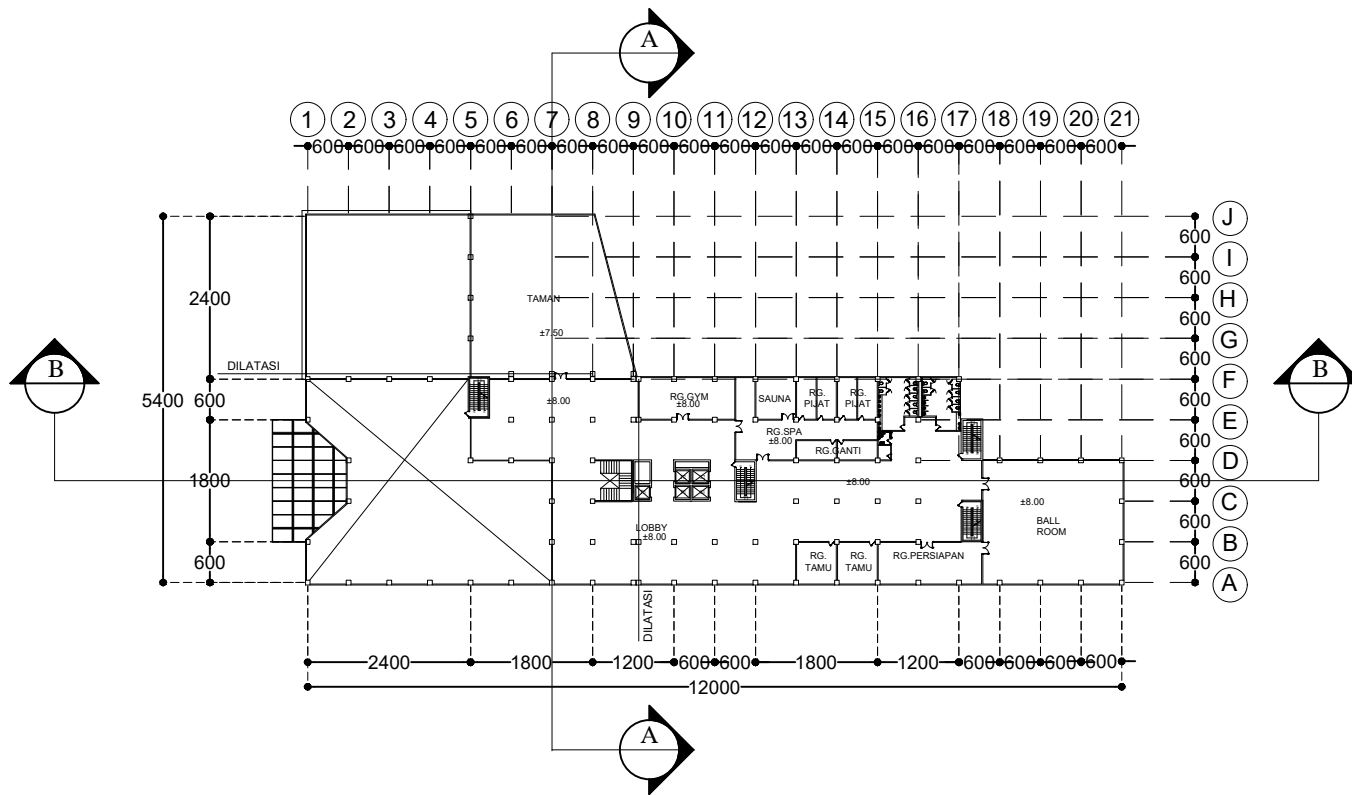

DENAH HOTEL LT 2



SCALE BAR 1:100

	MATA KULIAH	MAHASISWA/NIM	DOSEN PEMBIMBING	DOSEN PEMBIMBING	KETERANGAN
 <p>UNIVERSITAS SAM RATULANGI FAKULTAS TEKNIK JURUSAN ARSITEKTUR PRODI ARSITEKTUR</p>	DESAIN ARSITEKTUR V	<p>RINDA WULAN KALANGI (17021102011)</p>	<p>Ir. Octavianus H. A Rogi, ST, M.Si Dr.Valeria Woy, ST.,MT Prof. DR. Ir. Ar. Jefrev. I. Kindangen, DEA, IAI Cynthia E.V Wuisanq, ST,MurbHabMgt, PhD DR. Ir. Reny Syafrini, M.Ars</p>	<p>Ir. Octavianus H. A Rogi, ST, M.Si</p>	
	JUDUL TUGAS				
	CAPITAL INVESTMENT				
	MIXED USE				

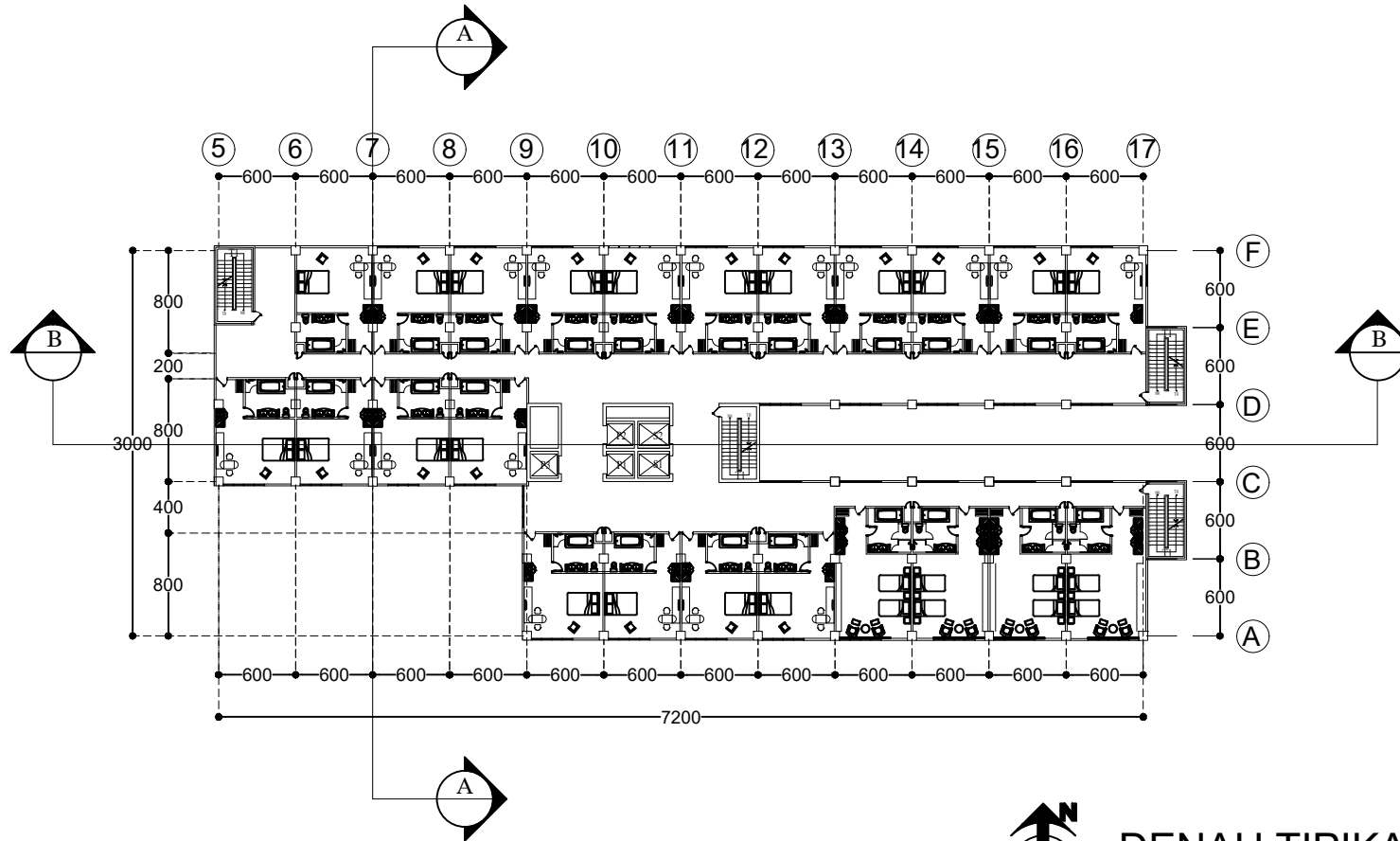

DENAH TIPIKAL LT 3-8



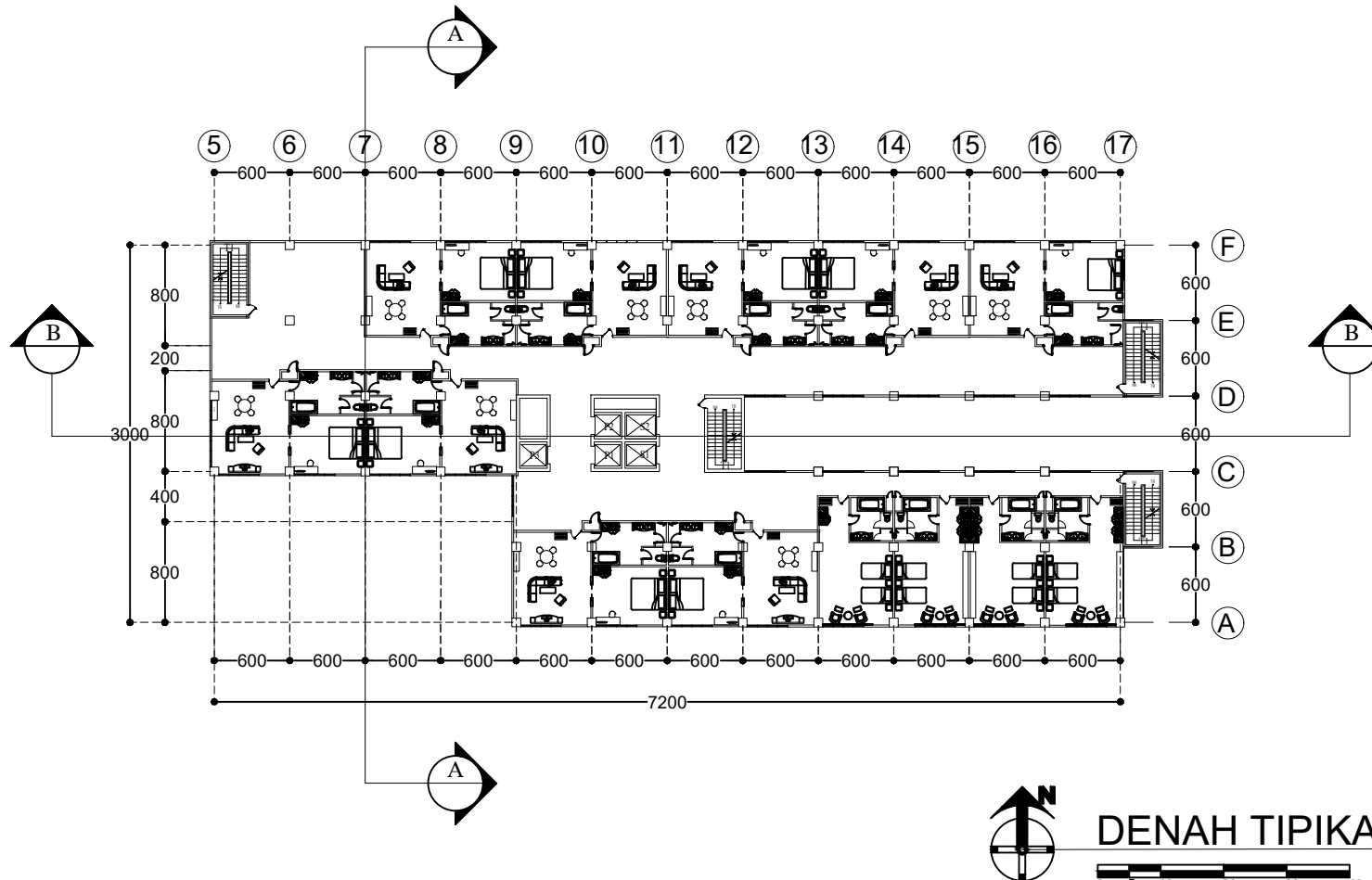

SCALE BAR 1:200

	MATA KULIAH	MAHASISWA/NIM	DOSEN PEMBIMBING	DOSEN PEMBIMBING	KETERANGAN
 <p>UNIVERSITAS SAM RATULANGI FAKULTAS TEKNIK JURUSAN ARSITEKTUR PRODI ARSITEKTUR</p>	DESAIN ARSITEKTUR V	<p>RINDA WULAN KALANGI (17021102011)</p>	<p>Ir. Octavianus H. A Rogi, ST, M.Si Dr.Valeria Woy, ST.,MT Prof. DR. Ir. Ar. Jefrev. I. Kindangen, DEA, IAI Cynthia E.V Wuisanq, ST,MURbHabMgt, PhD DR. Ir. Reny Syafrini, M.Ars</p>	<p>Ir. Octavianus H. A Rogi, ST, M.Si</p>	
	JUDUL TUGAS				
	CAPITAL INVESTMENT MIXED USE				

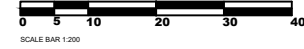

DENAH TIPIKAL LT 9-12



	MATA KULIAH	MAHASISWA/NIM	DOSEN PEMBIMBING	DOSEN PEMBIMBING	KETERANGAN
 <p data-bbox="280 1348 548 1476">UNIVERSITAS SAM RATULANGI FAKULTAS TEKNIK JURUSAN ARSITEKTUR PRODI ARSITEKTUR</p>	DESAIN ARSITEKTUR V	RINDA WULAN KALANGI (17021102011)	Ir. Octavianus H. A Rogi, ST, M.Si Dr.Valeria Woy, ST.,MT Prof. DR. Ir. Ar. Jefrev. I. Kindangen, DEA, IAI Cynthia E.V Wuisanq, ST,MurbHabMgt, PhD DR. Ir. Reny Syafrini, M.Ars	Ir. Octavianus H. A Rogi, ST, M.Si	
	JUDUL TUGAS CAPITAL INVESTMENT MIXED USE				

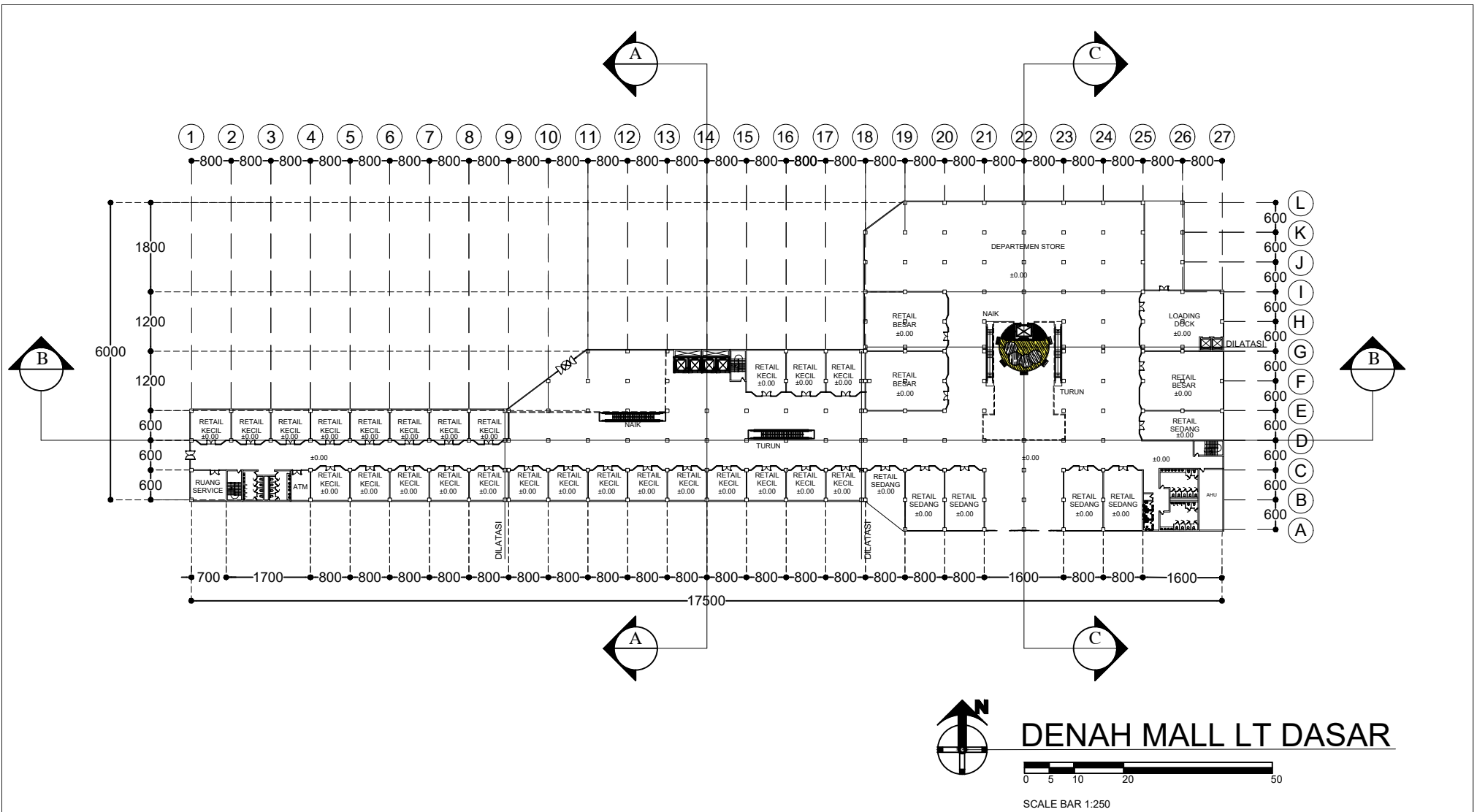

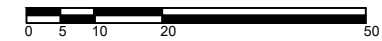

DENAH MALL LT DASAR

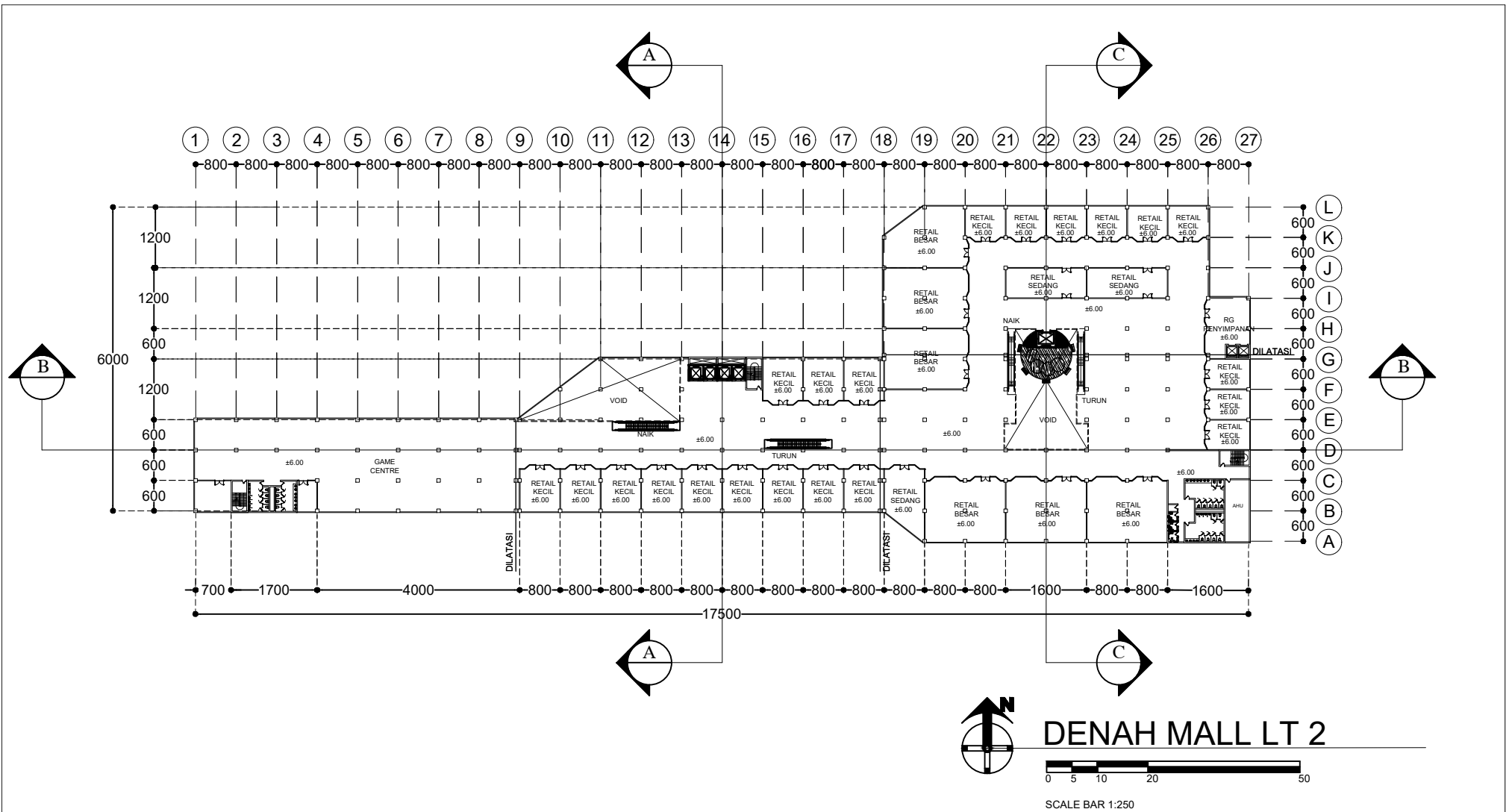

SCALE BAR 1:250

 <p>UNIVERSITAS SAM RATULANGI FAKULTAS TEKNIK JURUSAN ARSITEKTUR PRODI ARSITEKTUR</p>	MATA KULIAH	MAHASISWA/NIM	DOSEN PEMBIMBING	DOSEN PEMBIMBING	KETERANGAN
	DESAIN ARSITEKTUR V	RINDA WULAN KALANGI (17021102011)	Ir. Octavianus H. A Rogi, ST, M.Si Dr.Valeria Woy, ST.,MT Prof. DR. Ir. Ar. Jefrev. I. Kindangen, DEA, IAI Cynthia E.V Wuisanq, ST,MurbHabMgt, PhD DR. Ir. Reny Syafrini, M.Ars	Ir. Octavianus H. A Rogi, ST, M.Si	
	JUDUL TUGAS				
	CAPITAL INVESTMENT MIXED USE				



	MATA KULIAH	MAHASISWA/NIM	DOSEN PEMBIMBING	DOSEN PEMBIMBING	KETERANGAN
 <p>UNIVERSITAS SAM RATULANGI FAKULTAS TEKNIK JURUSAN ARSITEKTUR PRODI ARSITEKTUR</p>	DESAIN ARSITEKTUR V	<p>RINDA WULAN KALANGI (17021102011)</p>	<p>Ir. Octavianus H. A Rogi, ST, M.Si Dr.Valeria Woy, ST.,MT Prof. DR. Ir. Ar. Jefrev. I. Kindangen, DEA, IAI Cynthia E.V Wuisanq, ST,MurbHabMgt, PhD DR. Ir. Reny Syafrini, M.Ars</p>	<p>Ir. Octavianus H. A Rogi, ST, M.Si</p>	
	JUDUL TUGAS				
	CAPITAL INVESTMENT				
	MIXED USE				

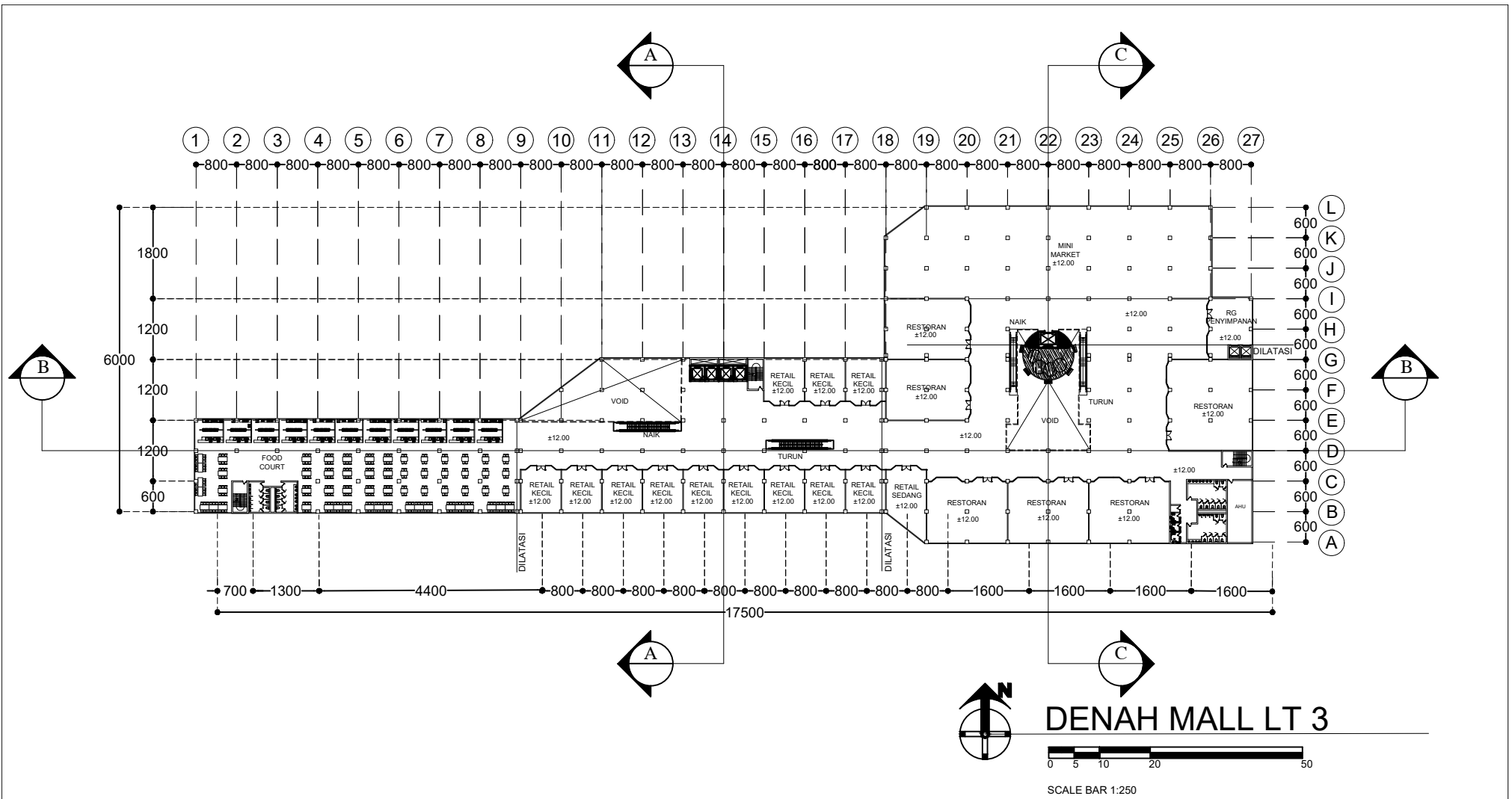

DENAH MALL LT 3
 SCALE BAR 1:250

	MATA KULIAH	MAHASISWA/NIM	DOSEN PEMBIMBING	DOSEN PEMBIMBING	KETERANGAN
 <p>UNIVERSITAS SAM RATULANGI FAKULTAS TEKNIK JURUSAN ARSITEKTUR PRODI ARSITEKTUR</p>	DESAIN ARSITEKTUR V	<p>RINDA WULAN KALANGI (17021102011)</p>	<p>Ir. Octavianus H. A Rogi, ST, M.Si Dr.Valeria Woy, ST.,MT Prof. DR. Ir. Ar. Jefrev. I. Kindangen, DEA, IAI Cynthia E.V Wuisanq, ST,MurbHabMgt, PhD DR. Ir. Reny Syafrini, M.Ars</p>	<p>Ir. Octavianus H. A Rogi, ST, M.Si</p>	
	JUDUL TUGAS				
	CAPITAL INVESTMENT				
	MIXED USE				

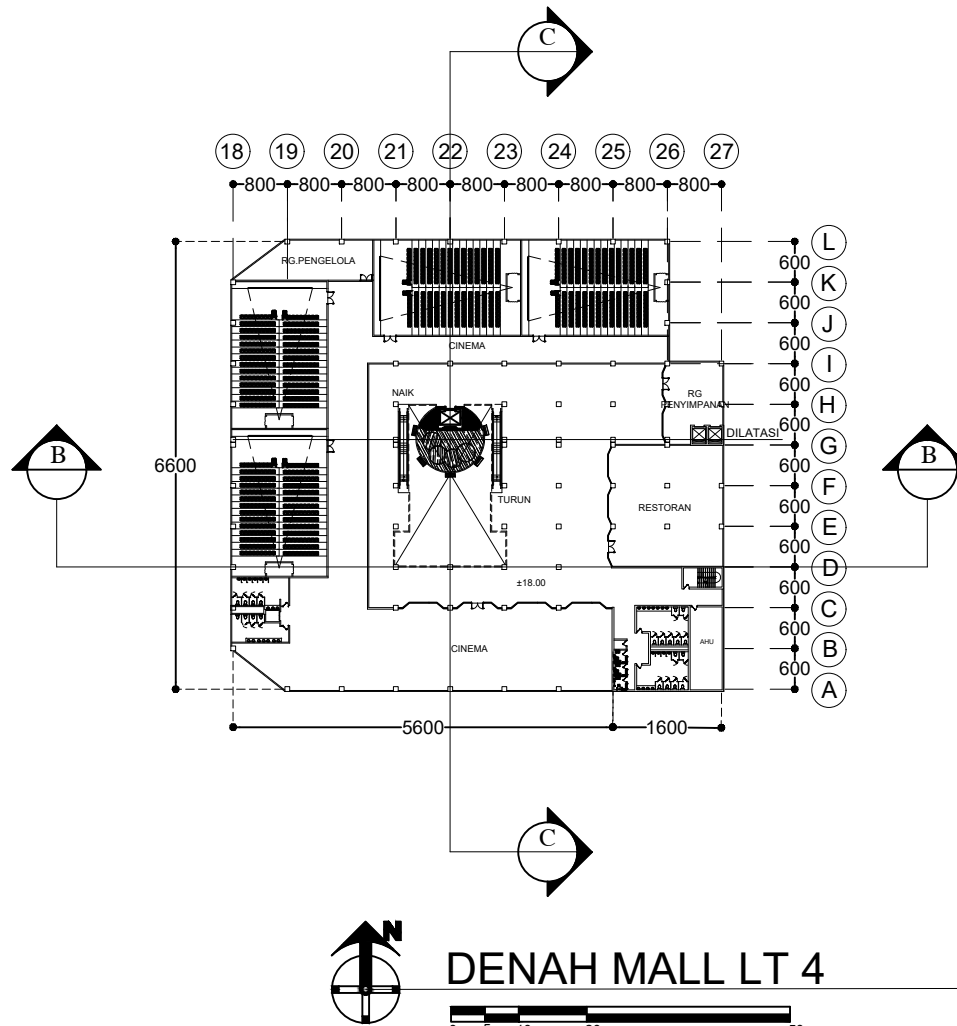

DENAH MALL LT 4

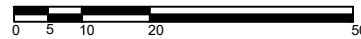

SCALE BAR 1:250

	MATA KULIAH	MAHASISWA/NIM	DOSEN PEMBIMBING	DOSEN PEMBIMBING	KETERANGAN
 <p>UNIVERSITAS SAM RATULANGI FAKULTAS TEKNIK JURUSAN ARSITEKTUR PRODI ARSITEKTUR</p>	DESAIN ARSITEKTUR V	<p>RINDA WULAN KALANGI (17021102011)</p>	<p>Ir. Octavianus H. A Rogi, ST, M.Si Dr.Valeria Woy, ST.,MT Prof. DR. Ir. Ar. Jefrev. I. Kindangen, DEA, IAI Cynthia E.V Wuisanq, ST,MURbHabMgt, PhD DR. Ir. Reny Syafrini, M.Ars</p>	<p>Ir. Octavianus H. A Rogi, ST, M.Si</p>	
	JUDUL TUGAS				
	CAPITAL INVESTMENT				
	MIXED USE				

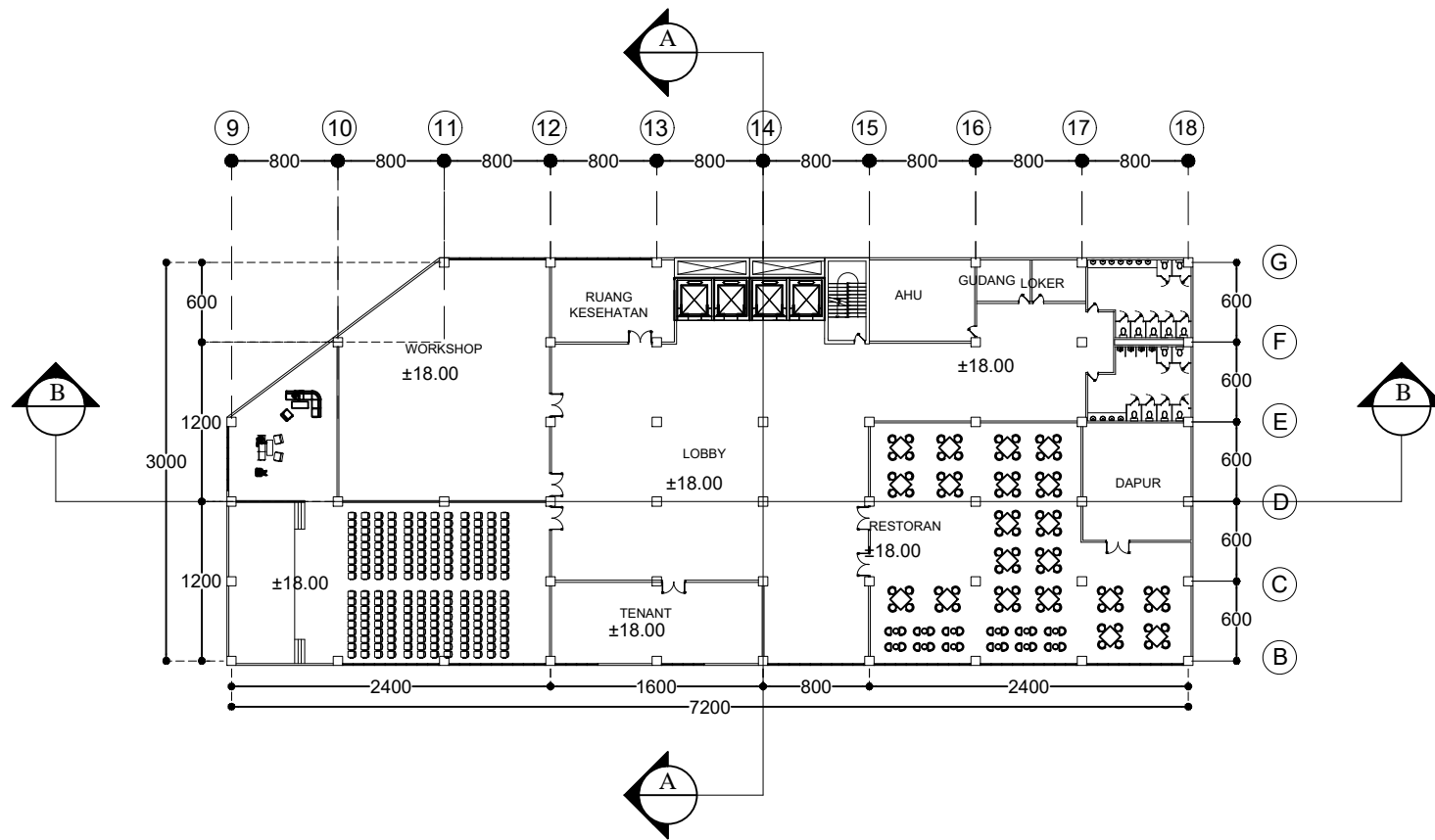

DENAH OFFICE LT DASAR



	MATA KULIAH	MAHASISWA/NIM	DOSEN PEMBIMBING	DOSEN PEMBIMBING	KETERANGAN
 <p>UNIVERSITAS SAM RATULANGI FAKULTAS TEKNIK JURUSAN ARSITEKTUR PRODI ARSITEKTUR</p>	DESAIN ARSITEKTUR V	<p>RINDA WULAN KALANGI (17021102011)</p>	<p>Ir. Octavianus H. A Rogi, ST, M.Si Dr.Valeria Woy, ST.,MT Prof. DR. Ir. Ar. Jefrev. I. Kindangan, DEA, IAI Cynthia E.V Wuisanq, ST,MURbHabMgt, PhD DR. Ir. Reny Syafrini, M.Ars</p>	<p>Ir. Octavianus H. A Rogi, ST, M.Si</p>	
	JUDUL TUGAS				
	CAPITAL INVESTMENT				
	MIXED USE				

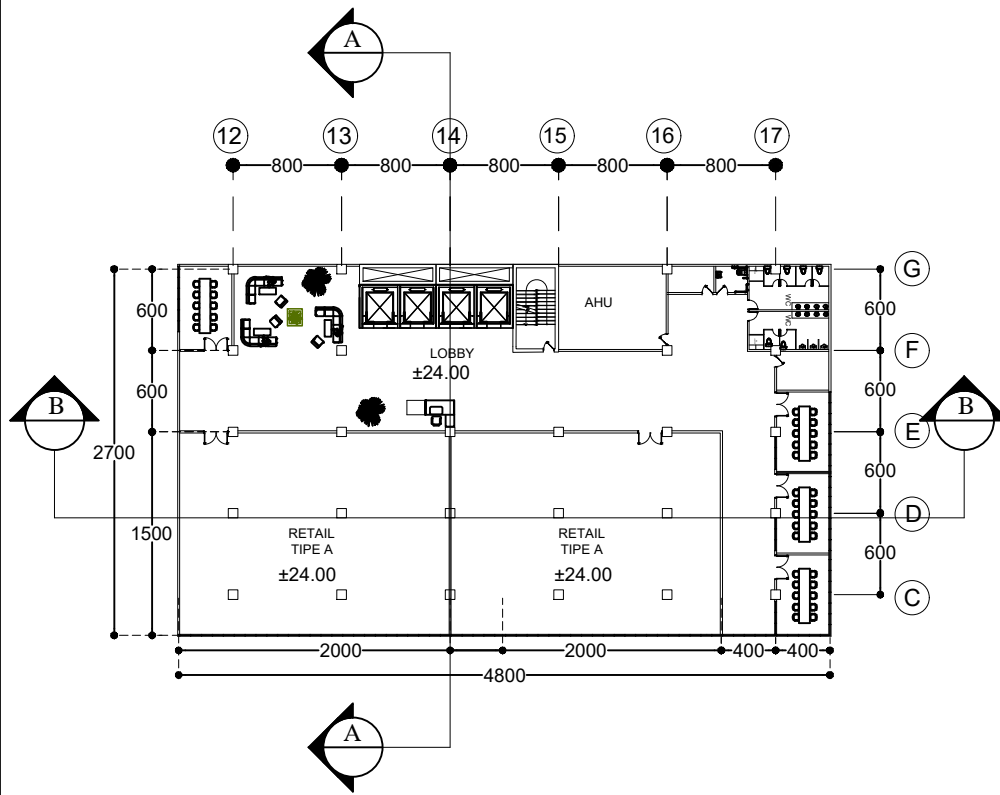

SCALE BAR 1:200
DENAH OFFICE LT 2 dan 3

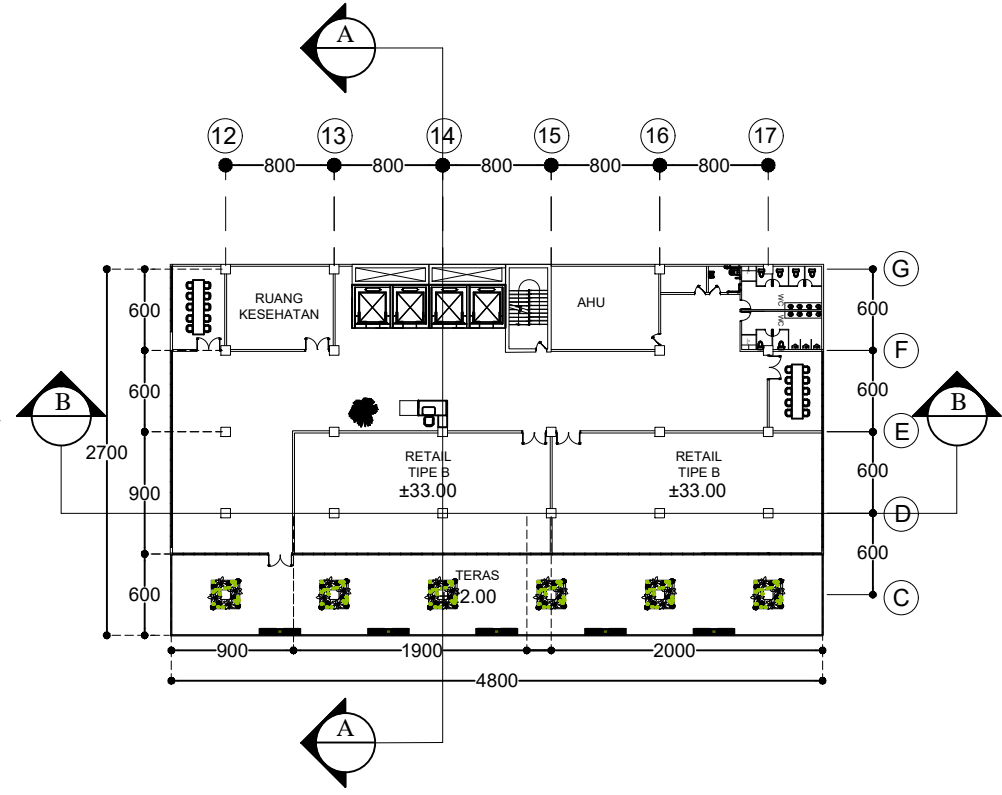

SCALE BAR 1:200
DENAH OFFICE LT 4 dan 5



UNIVERSITAS SAM RATULANGI
 FAKULTAS TEKNIK
 JURUSAN ARSITEKTUR
 PRODI ARSITEKTUR

MATA KULIAH	MAHASISWA/NIM	DOSEN PEMBIMBING	DOSEN PEMBIMBING	KETERANGAN
DESAIN ARSITEKTUR V	RINDA WULAN KALANGI (17021102011)	Ir. Octavianus H. A Rogi, ST, M.Si Dr.Valeria Woy, ST.,MT Prof. DR. Ir. Ar. Jefrev. I. Kindangen, DEA, IAI Cynthia E.V Wuisanq, ST,MurbHabMgt, PhD DR. Ir. Reny Syafrini, M.Ars	Ir. Octavianus H. A Rogi, ST, M.Si	
JUDUL TUGAS				
CAPITAL INVESTMENT MIXED USE				

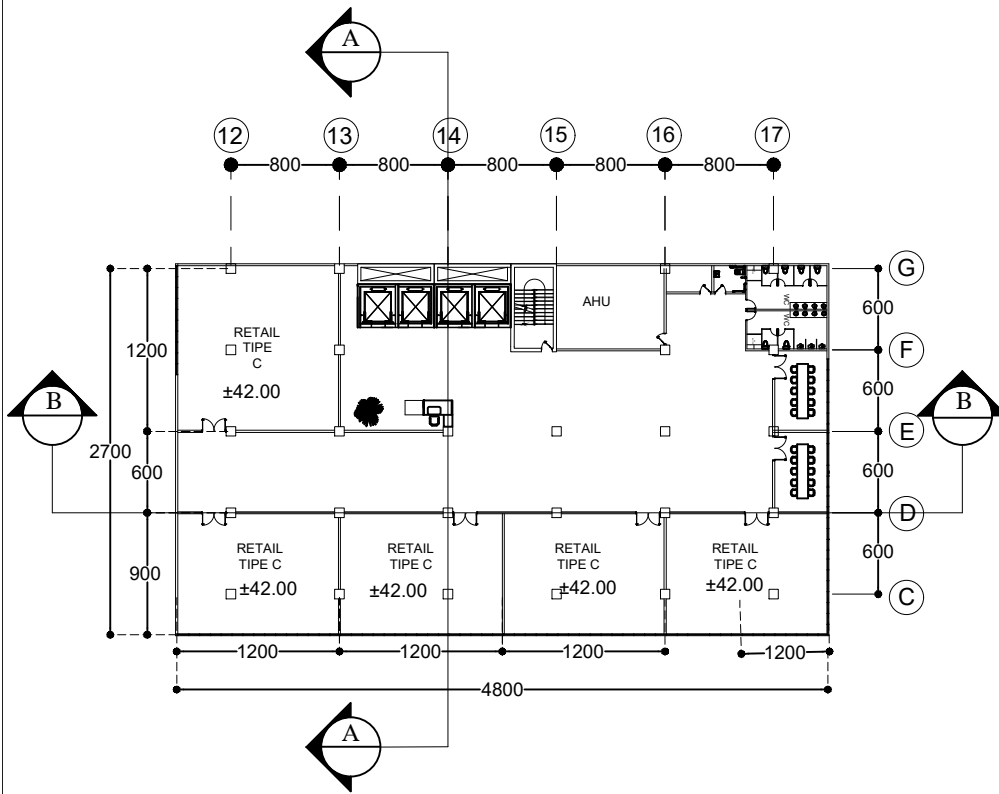

DENAH OFFICE LT 6-8

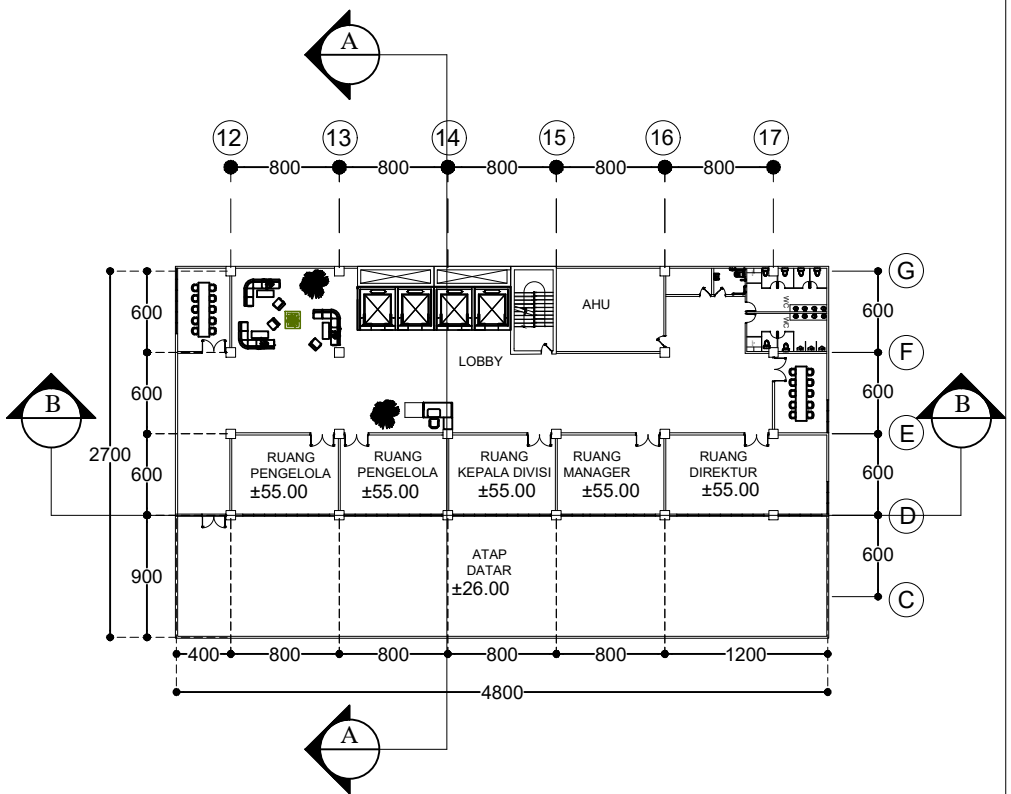
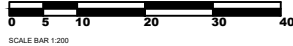

DENAH OFFICE LT 9



UNIVERSITAS SAM RATULANGI
 FAKULTAS TEKNIK
 JURUSAN ARSITEKTUR
 PRODI ARSITEKTUR

MATA KULIAH	MAHASISWA/NIM	DOSEN PEMBIMBING	DOSEN PEMBIMBING	KETERANGAN
DESAIN ARSITEKTUR V	RINDA WULAN KALANGI (17021102011)	Ir. Octavianus H. A Rogi, ST, M.Si Dr.Valeria Woy, ST.,MT Prof. DR. Ir. Ar. Jefrev. I. Kindangen, DEA, IAI Cynthia E.V Wuisanq, ST,MurbHabMgt, PhD DR. Ir. Reny Syafrini, M.Ars	Ir. Octavianus H. A Rogi, ST, M.Si	
JUDUL TUGAS				
CAPITAL INVESTMENT				
MIXED USE				



SITEPLAN

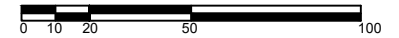

SCALE BAR 1:500

		MAHASISWA/NIM	DOSEN PEMBIMBING	DOSEN PEMBIMBING	KETERANGAN
 <p>UNIVERSITAS SAM RATULANGI FAKULTAS TEKNIK JURUSAN ARSITEKTUR PRODI ARSITEKTUR</p>	DESAIN ARSITEKTUR V	<p>RINDA WULAN KALANGI (17021102011)</p>	<p>Ir. Octavianus H. A Rogi, ST, M.Si Dr.Valeria Woy, ST.,MT Prof. DR. Ir. Ar. Jefrev. I. Kindangen, DEA, IAI Cynthia E.V Wuisanq, ST,MUrbHabMgt, PhD DR. Ir. Reny Syafrini, M.Ars</p>	<p>Ir. Octavianus H. A Rogi, ST, M.Si</p>	
	JUDUL TUGAS				
	CAPITAL INVESTMENT MIXED USE				

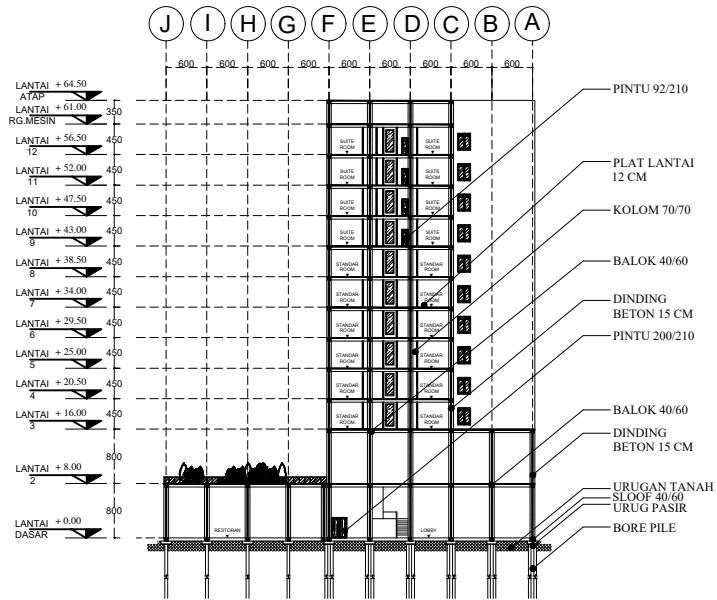

POTONGAN A-A HOTEL

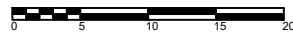

SCALE BAR 1:100

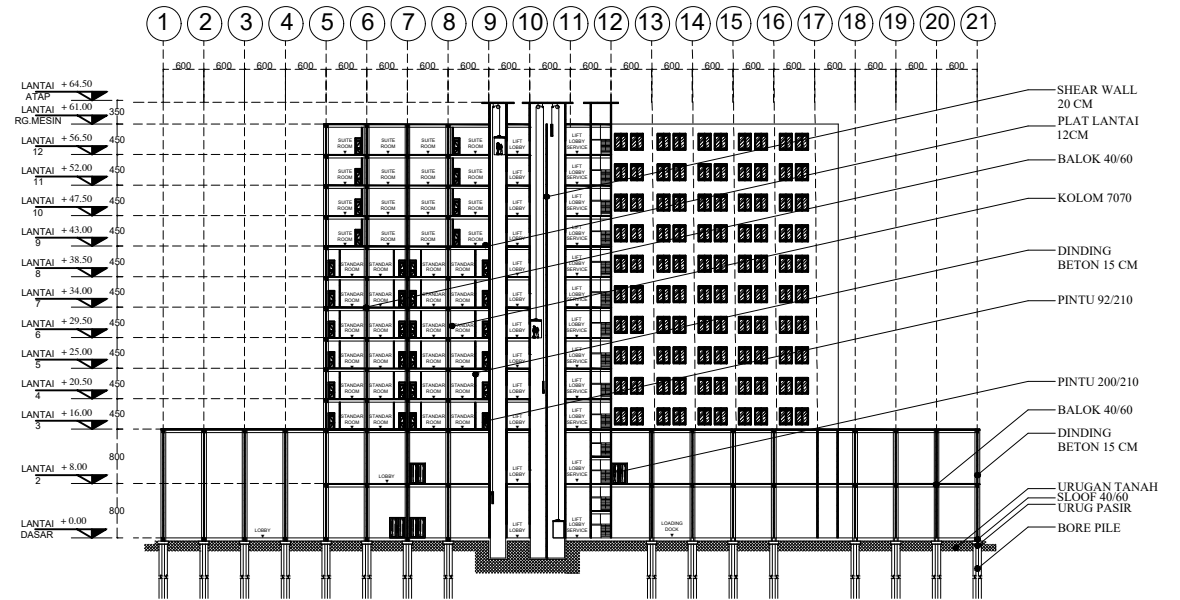

POTONGAN B-B HOTEL

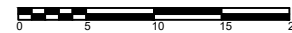

SCALE BAR 1:100



UNIVERSITAS SAM RATULANGI
FAKULTAS TEKNIK
JURUSAN ARSITEKTUR
PRODI ARSITEKTUR

MATA KULIAH	MAHASISWA/NIM	DOSEN PEMBIMBING	DOSEN PEMBIMBING	KETERANGAN
DESAIN ARSITEKTUR V	RINDA WULAN KALANGI (17021102011)	Ir. Octavianus H. A Rogi, ST, M.Si Dr.Valeria Woy, ST.,MT Prof. DR. Ir. Ar. Jefrev. I. Kindangan, DEA, IAI Cynthia E.V Wuisanq, ST,MURbHabMgt, PhD DR. Ir. Reny Syafrini, M.Ars	Ir. Octavianus H. A Rogi, ST, M.Si	
JUDUL TUGAS				
CAPITAL INVESTMENT MIXED USE				

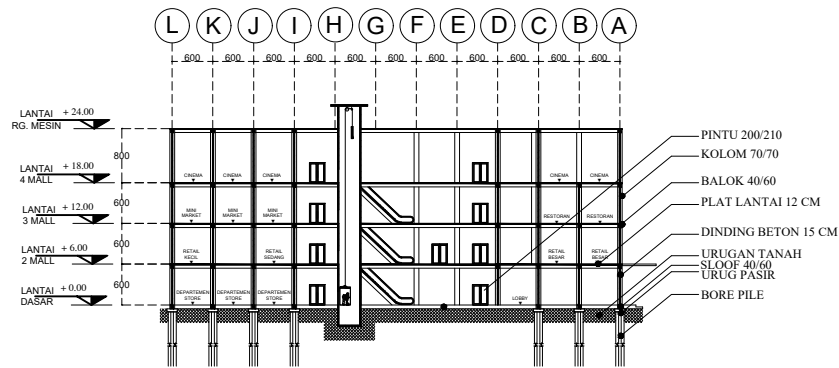
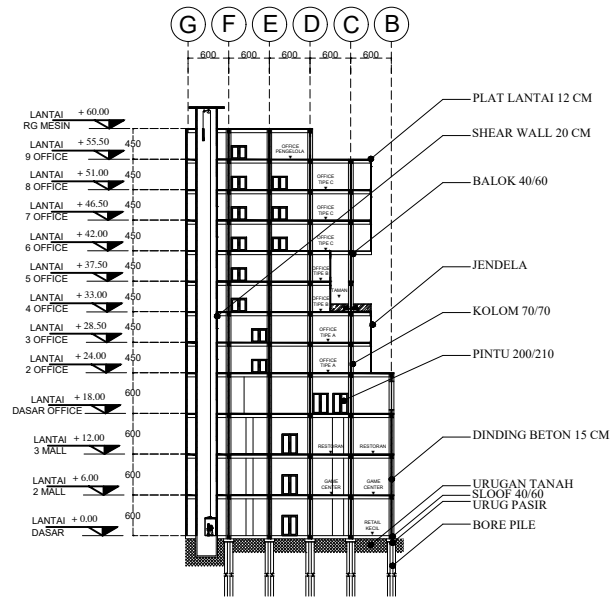

POTONGAN A-A MALL DAN OFFICE

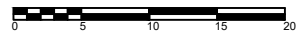

SCALE BAR 1:100



POTONGAN C-C MALL DAN OFFICE



SCALE BAR 1:100



UNIVERSITAS SAM RATULANGI
FAKULTAS TEKNIK
JURUSAN ARSITEKTUR
PRODI ARSITEKTUR

MATA KULIAH	MAHASISWA/NIM	DOSEN PEMBIMBING	DOSEN PEMBIMBING	KETERANGAN
DESAIN ARSITEKTUR V	RINDA WULAN KALANGI (17021102011)	Ir. Octavianus H. A Rogi, ST, M.Si Dr.Valeria Woy, ST.,MT Prof. DR. Ir. Ar. Jefrev. I. Kindangen, DEA, IAI Cynthia E.V Wuisanq, ST,MURbHabMgt, PhD DR. Ir. Reny Syafrini, M.Ars	Ir. Octavianus H. A Rogi, ST, M.Si	
JUDUL TUGAS				
CAPITAL INVESTMENT MIXED USE				

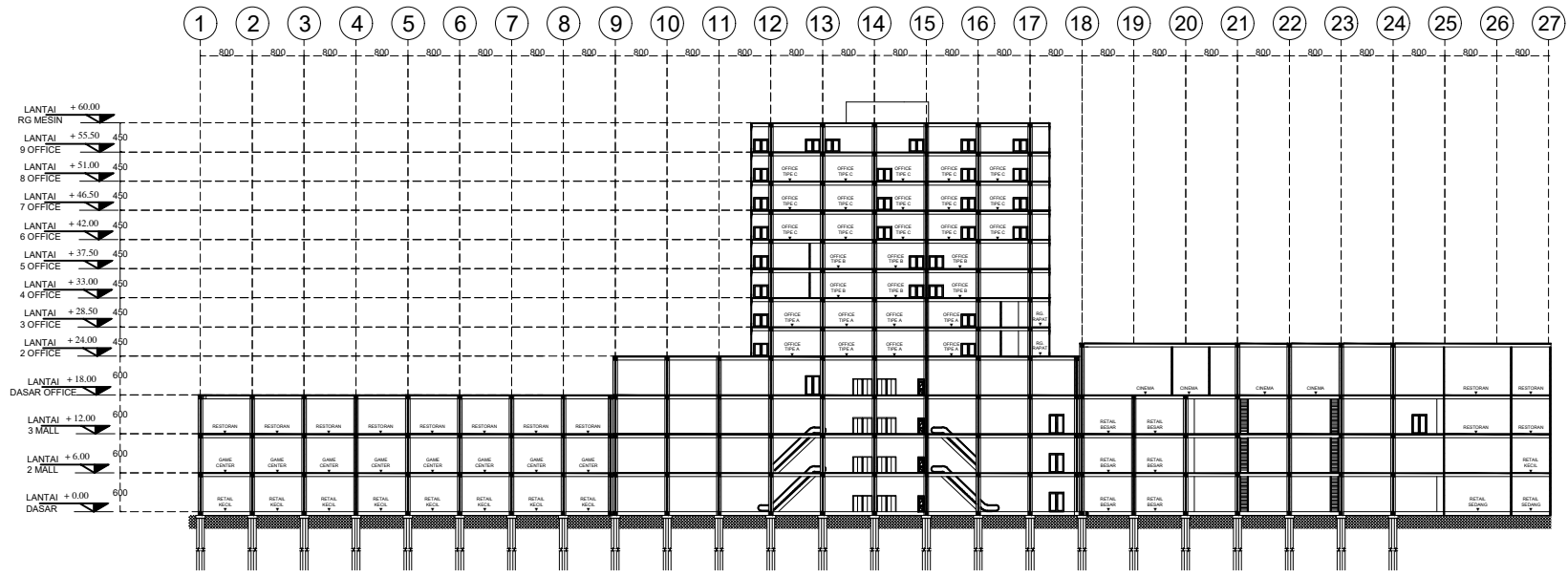

POTONGAN B-B MALL DAN OFFICE

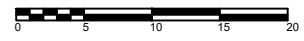

SCALE BAR 1:100

 UNIVERSITAS SAM RATULANGI FAKULTAS TEKNIK JURUSAN ARSITEKTUR PRODI ARSITEKTUR	MATA KULIAH	MAHASISWA/NIM	DOSEN PEMBIMBING	DOSEN PEMBIMBING	KETERANGAN
	DESAIN ARSITEKTUR V	RINDA WULAN KALANGI (17021102011)	Ir. Octavianus H. A Rogi, ST, M.Si Dr.Valeria Woy, ST.,MT Prof. DR. Ir. Ar. Jefrev. I. Kindangen, DEA, IAI Cynthia E.V Wuisanq, ST,MUrbHabMgt, PhD DR. Ir. Reny Syafrini, M.Ars	Ir. Octavianus H. A Rogi, ST, M.Si	
	JUDUL TUGAS				
	CAPITAL INVESTMENT MIXED USE				



TAMPAK DEPAN BANGUNAN

	MATA KULIAH	MAHASISWA/NIM	DOSEN PEMBIMBING	DOSEN PEMBIMBING	KETERANGAN
 <p>UNIVERSITAS SAM RATULANGI FAKULTAS TEKNIK JURUSAN ARSITEKTUR PRODI ARSITEKTUR</p>	DESAIN ARSITEKTUR V	<p>RINDA WULAN KALANGI (17021102011)</p>	<p>Ir. Octavianus H. A Rogi, ST, M.Si Dr.Valeria Woy, ST.,MT Prof. DR. Ir. Ar. Jefrev. I. Kindangen, DEA, IAI Cynthia E.V Wuisanq, ST,MUrbHabMgt, PhD DR. Ir. Reny Syafrini, M.Ars</p>	<p>Ir. Octavianus H. A Rogi, ST, M.Si</p>	
	JUDUL TUGAS				
	CAPITAL INVESTMENT MIXED USE				

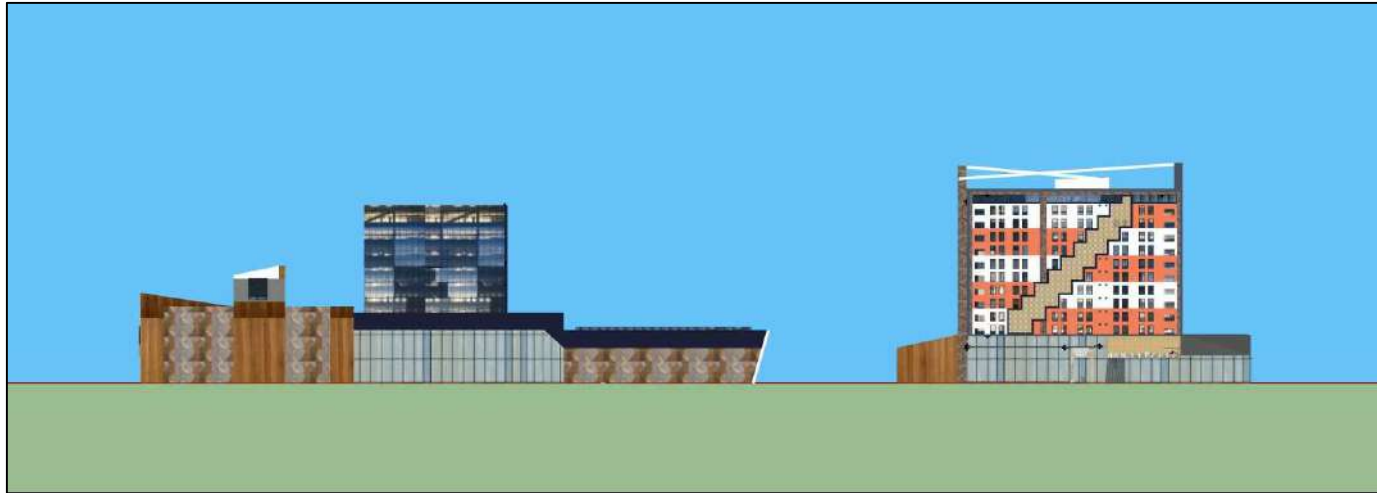

TAMPAK BELAKANG BANGUNAN

	MATA KULIAH	MAHASISWA/NIM	DOSEN PEMBIMBING	DOSEN PEMBIMBING	KETERANGAN
 <p>UNIVERSITAS SAM RATULANGI FAKULTAS TEKNIK JURUSAN ARSITEKTUR PRODI ARSITEKTUR</p>	DESAIN ARSITEKTUR V	<p>RINDA WULAN KALANGI (17021102011)</p>	<p>Ir. Octavianus H. A Rogi, ST, M.Si Dr.Valeria Woy, ST.,MT Prof. DR. Ir. Ar. Jefrev. I. Kindangen, DEA, IAI Cynthia E.V Wuisanq, ST,MUrbHabMgt, PhD DR. Ir. Reny Syafrini, M.Ars</p>	<p>Ir. Octavianus H. A Rogi, ST, M.Si</p>	
	JUDUL TUGAS				
	CAPITAL INVESTMENT MIXED USE				



TAMPAK KIRI HOTEL



TAMPAK KANAN HOTEL

	MATA KULIAH	MAHASISWA/NIM	DOSEN PEMBIMBING	DOSEN PEMBIMBING	KETERANGAN
 <p>UNIVERSITAS SAM RATULANGI FAKULTAS TEKNIK JURUSAN ARSITEKTUR PRODI ARSITEKTUR</p>	DESAIN ARSITEKTUR V	<p>RINDA WULAN KALANGI (17021102011)</p>	<p>Ir. Octavianus H. A Rogi, ST, M.Si Dr.Valeria Woy, ST.,MT Prof. DR. Ir. Ar. Jefrev. I. Kindangen, DEA, IAI Cynthia E.V Wuisanq, ST,MUrbHabMgt, PhD DR. Ir. Reny Syafrini, M.Ars</p>	<p>Ir. Octavianus H. A Rogi, ST, M.Si</p>	
	JUDUL TUGAS				
	CAPITAL INVESTMENT MIXED USE				



POTONGAN ORTHOGONAL HOTEL



UNIVERSITAS SAM RATULANGI
FAKULTAS TEKNIK
JURUSAN ARSITEKTUR
PRODI ARSITEKTUR

MATA KULIAH	MAHASISWA/NIM	DOSEN PEMBIMBING	DOSEN PEMBIMBING	KETERANGAN
DESAIN ARSITEKTUR V	RINDA WULAN KALANGI (17021102011)	Ir. Octavianus H. A Rogi, ST, M.Si Dr.Valeria Woy, ST.,MT Prof. DR. Ir. Ar. Jefrev. I. Kindangen, DEA, IAI Cynthia E.V Wuisanq, ST,MUrbHabMgt, PhD DR. Ir. Reny Syafrini, M.Ars	Ir. Octavianus H. A Rogi, ST, M.Si	
JUDUL TUGAS				
CAPITAL INVESTMENT MIXED USE				

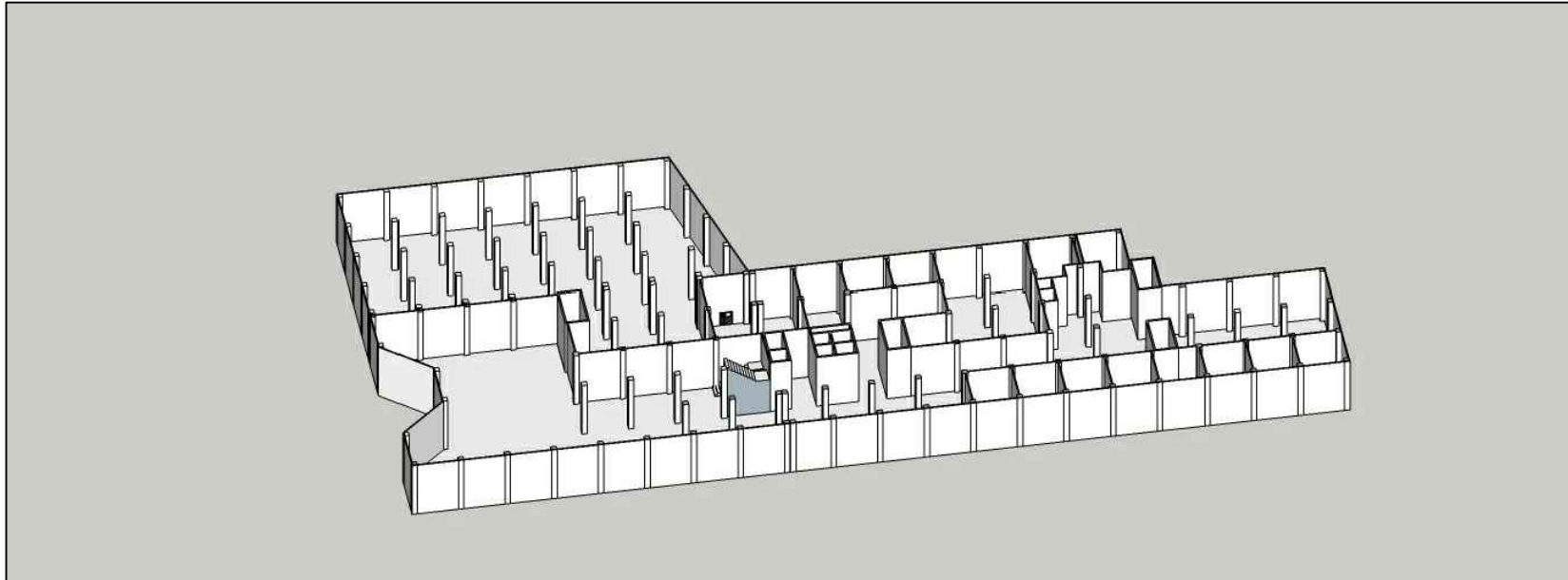

ISOMETRI DENAH HOTEL

	MATA KULIAH	MAHASISWA/NIM	DOSEN PEMBIMBING	DOSEN PEMBIMBING	KETERANGAN
 <p>UNIVERSITAS SAM RATULANGI FAKULTAS TEKNIK JURUSAN ARSITEKTUR PRODI ARSITEKTUR</p>	DESAIN ARSITEKTUR V	<p>RINDA WULAN KALANGI (17021102011)</p>	<p>Ir. Octavianus H. A Rogi, ST, M.Si Dr.Valeria Woy, ST.,MT Prof. DR. Ir. Ar. Jefrev. I. Kindangen, DEA, IAI Cynthia E.V Wuisanq, ST,MUrbHabMgt, PhD DR. Ir. Reny Syafrini, M.Ars</p>	<p>Ir. Octavianus H. A Rogi, ST, M.Si</p>	
	JUDUL TUGAS				
	CAPITAL INVESTMENT MIXED USE				

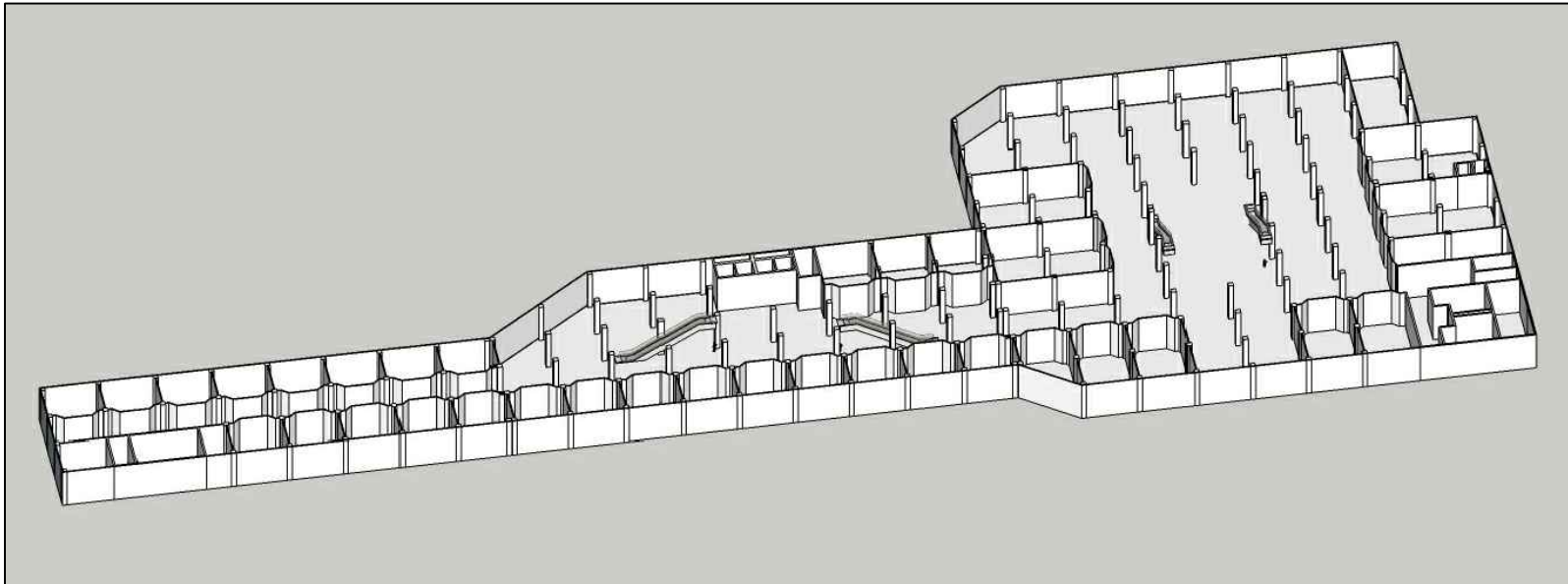

ISOMETRI DENAH MALL & OFFICE

	MATA KULIAH	MAHASISWA/NIM	DOSEN PEMBIMBING	DOSEN PEMBIMBING	KETERANGAN
 <p>UNIVERSITAS SAM RATULANGI FAKULTAS TEKNIK JURUSAN ARSITEKTUR PRODI ARSITEKTUR</p>	DESAIN ARSITEKTUR V	<p>RINDA WULAN KALANGI (17021102011)</p>	<p>Ir. Octavianus H. A Rogi, ST, M.Si Dr.Valeria Woy, ST.,MT Prof. DR. Ir. Ar. Jefrev. I. Kindangen, DEA, IAI Cynthia E.V Wuisanq, ST,MUrbHabMgt, PhD DR. Ir. Reny Syafrini, M.Ars</p>	<p>Ir. Octavianus H. A Rogi, ST, M.Si</p>	
	JUDUL TUGAS				
	CAPITAL INVESTMENT MIXED USE				



ISOMETRI STRUKTUR HOTEL

	MATA KULIAH	MAHASISWA/NIM	DOSEN PEMBIMBING	DOSEN PEMBIMBING	KETERANGAN
 <p>UNIVERSITAS SAM RATULANGI FAKULTAS TEKNIK JURUSAN ARSITEKTUR PRODI ARSITEKTUR</p>	DESAIN ARSITEKTUR V	<p>RINDA WULAN KALANGI (17021102011)</p>	<p>Ir. Octavianus H. A Rogi, ST, M.Si Dr.Valeria Woy, ST.,MT Prof. DR. Ir. Ar. Jefrev. I. Kindangen, DEA, IAI Cynthia E.V Wuisanq, ST,MUrbHabMgt, PhD DR. Ir. Reny Syafrini, M.Ars</p>	<p>Ir. Octavianus H. A Rogi, ST, M.Si</p>	
	JUDUL TUGAS				
	CAPITAL INVESTMENT MIXED USE				

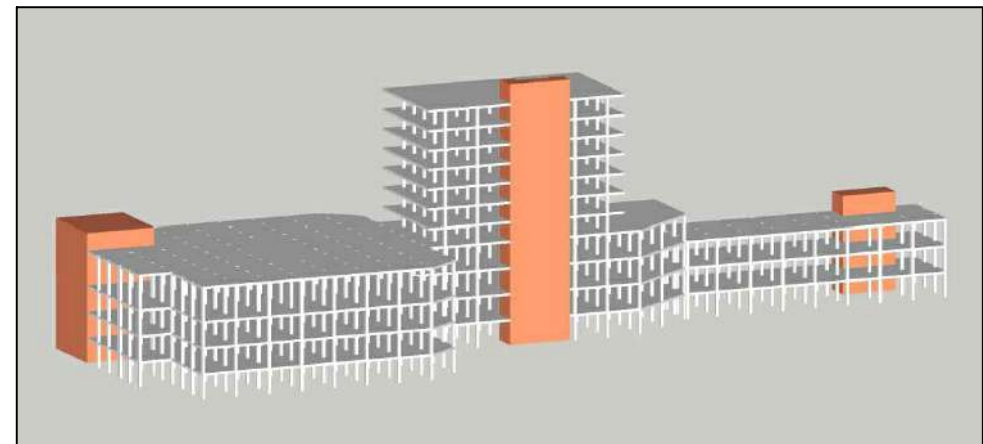
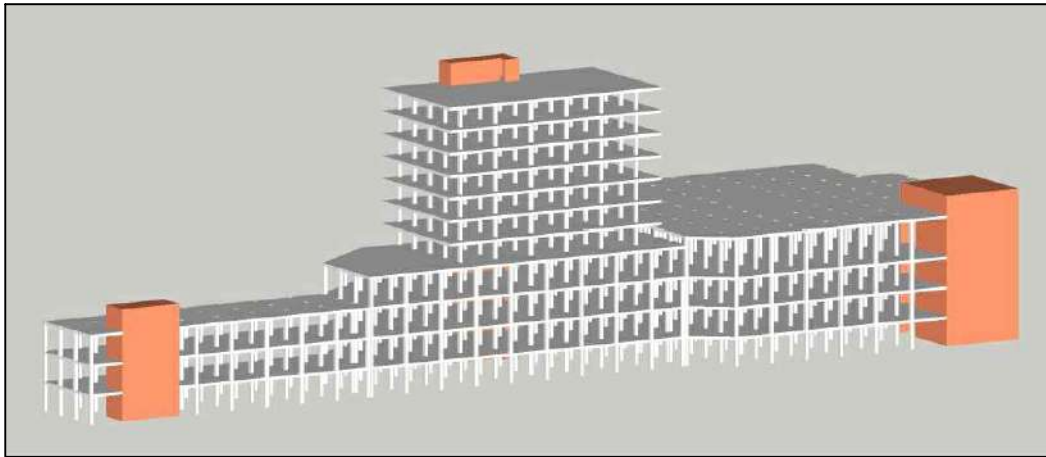

ISOMETRI STRUKTUR MALL & OFFICE



UNIVERSITAS SAM RATULANGI
 FAKULTAS TEKNIK
 JURUSAN ARSITEKTUR
 PRODI ARSITEKTUR

MATA KULIAH	MAHASISWA/NIM	DOSEN PEMBIMBING	DOSEN PEMBIMBING	KETERANGAN
DESAIN ARSITEKTUR V	RINDA WULAN KALANGI (17021102011)	Ir. Octavianus H. A Rogi, ST, M.Si Dr.Valeria Woy, ST.,MT Prof. DR. Ir. Ar. Jefrev. I. Kindangen, DEA, IAI Cynthia E.V Wuisanq, ST,MUrbHabMgt, PhD DR. Ir. Reny Syafrini, M.Ars	Ir. Octavianus H. A Rogi, ST, M.Si	
JUDUL TUGAS				
CAPITAL INVESTMENT MIXED USE				

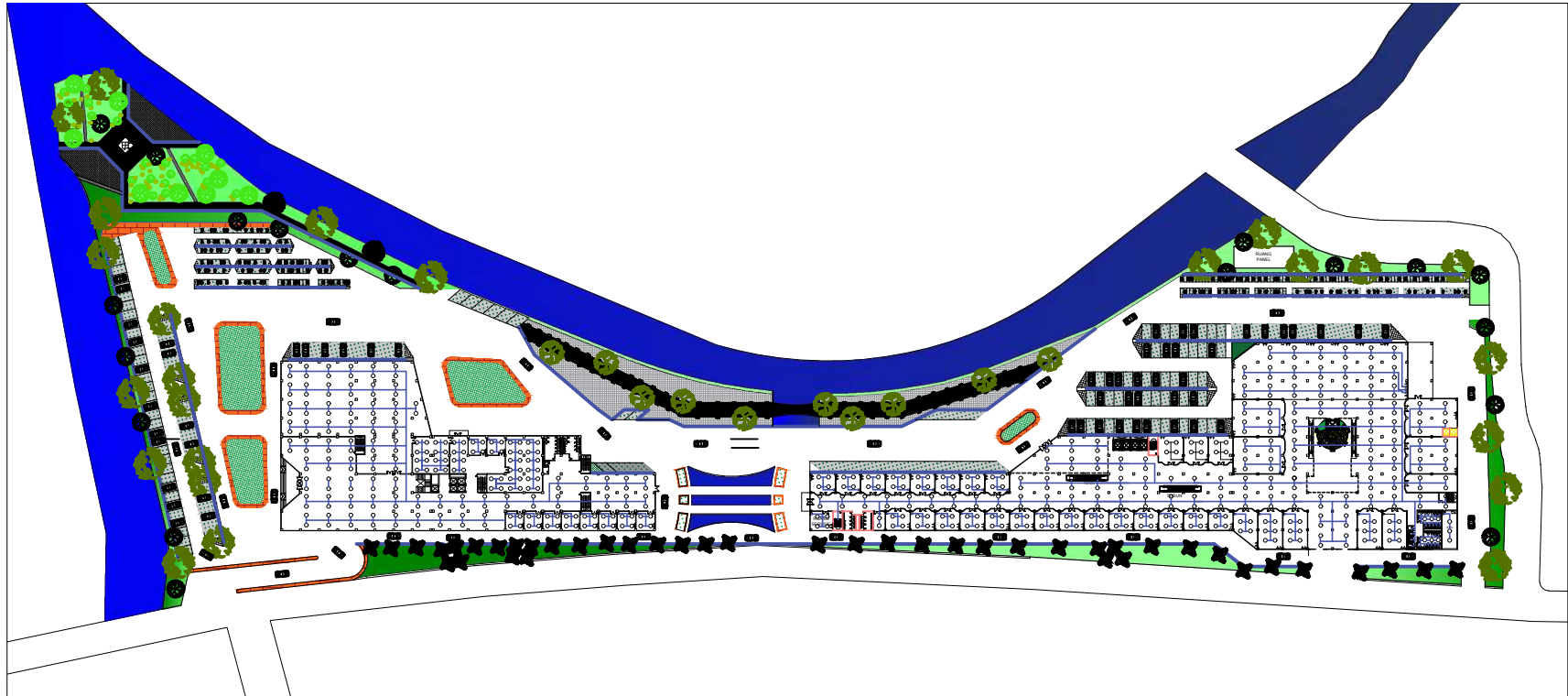

KETERANGAN

- Lampu Downlight
- ▭ Panel
- Ruang Panel
- D⁺ Saklar Ganda
- D⁻ Stop Kontak
- Jaringan Listrik

UTILITAS LISTRIK

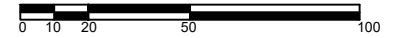

SCALE BAR 1:500

		MAHASISWA/NIM	DOSEN PEMBIMBING	DOSEN PEMBIMBING	KETERANGAN
 <p>UNIVERSITAS SAM RATULANGI FAKULTAS TEKNIK JURUSAN ARSITEKTUR PRODI ARSITEKTUR</p>	DESAIN ARSITEKTUR V	<p>RINDA WULAN KALANGI (17021102011)</p>	<p>Ir. Octavianus H. A Rogi, ST, M.Si Dr.Valeria Woy, ST.,MT Prof. DR. Ir. Ar. Jefrev. I. Kindangen, DEA, IAI Cynthia E.V Wuisanq, ST,MURbHabMgt, PhD DR. Ir. Reny Syafrini, M.Ars</p>	<p>Ir. Octavianus H. A Rogi, ST, M.Si</p>	
	JUDUL TUGAS				
	CAPITAL INVESTMENT MIXED USE				



PESPEKTIF GLOBAL

	MATA KULIAH	MAHASISWA/NIM	DOSEN PEMBIMBING	DOSEN PEMBIMBING	KETERANGAN
 <p>UNIVERSITAS SAM RATULANGI FAKULTAS TEKNIK JURUSAN ARSITEKTUR PRODI ARSITEKTUR</p>	DESAIN ARSITEKTUR V	<p>RINDA WULAN KALANGI (17021102011)</p>	<p>Ir. Octavianus H. A Rogi, ST, M.Si Dr.Valeria Woy, ST.,MT Prof. DR. Ir. Ar. Jefrev. I. Kindangen, DEA, IAI Cynthia E.V Wuisanq, ST,MURbHabMgt, PhD DR. Ir. Reny Syafrini, M.Ars</p>	<p>Ir. Octavianus H. A Rogi, ST, M.Si</p>	
	JUDUL TUGAS				
	CAPITAL INVESTMENT MIXED USE				

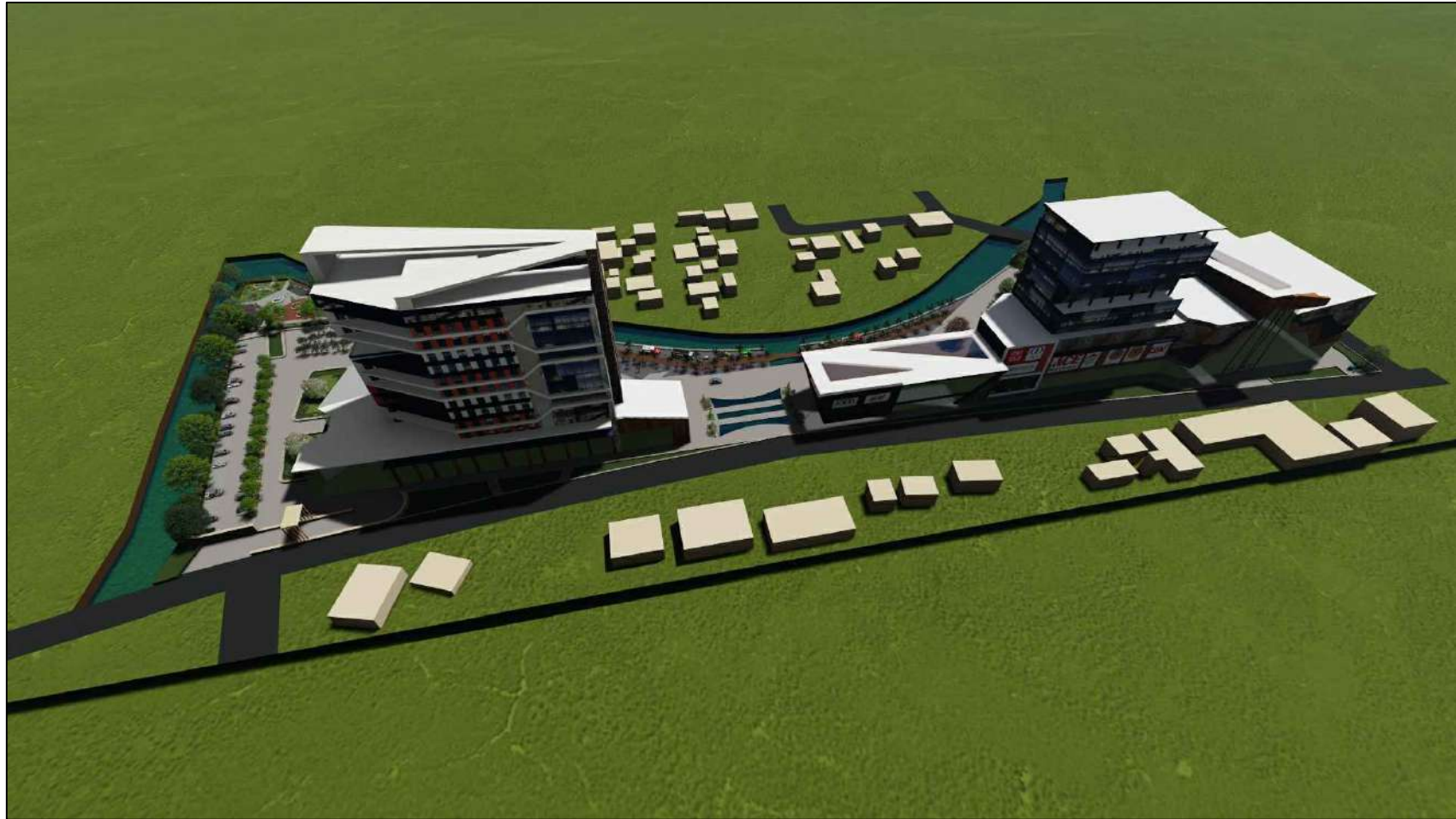

PERSPEKTIF GLOBAL MATA BURUNG

	MATA KULIAH	MAHASISWA/NIM	DOSEN PEMBIMBING	DOSEN PEMBIMBING	KETERANGAN
 <p>UNIVERSITAS SAM RATULANGI FAKULTAS TEKNIK JURUSAN ARSITEKTUR PRODI ARSITEKTUR</p>	DESAIN ARSITEKTUR V	<p>RINDA WULAN KALANGI (17021102011)</p>	<p>Ir. Octavianus H. A Rogi, ST, M.Si Dr.Valeria Woy, ST.,MT Prof. DR. Ir. Ar. Jefrev. I. Kindangen, DEA, IAI Cynthia E.V Wuisanq, ST,MURbHabMgt, PhD DR. Ir. Reny Syafrini, M.Ars</p>	<p>Ir. Octavianus H. A Rogi, ST, M.Si</p>	
	JUDUL TUGAS				
	CAPITAL INVESTMENT MIXED USE				



PERSPEKTIF GLOBAL MATA BURUNG

	MATA KULIAH	MAHASISWA/NIM	DOSEN PEMBIMBING	DOSEN PEMBIMBING	KETERANGAN
 <p>UNIVERSITAS SAM RATULANGI FAKULTAS TEKNIK JURUSAN ARSITEKTUR PRODI ARSITEKTUR</p>	DESAIN ARSITEKTUR V	<p>RINDA WULAN KALANGI (17021102011)</p>	<p>Ir. Octavianus H. A Rogi, ST, M.Si Dr.Valeria Woy, ST.,MT Prof. DR. Ir. Ar. Jefrev. I. Kindangen, DEA, IAI Cynthia E.V Wuisanq, ST,MURbHabMgt, PhD DR. Ir. Reny Syafrini, M.Ars</p>	<p>Ir. Octavianus H. A Rogi, ST, M.Si</p>	
	JUDUL TUGAS				
	CAPITAL INVESTMENT MIXED USE				



SPOT RUANG DALAM KAMAR TIPIKAL HOTEL

	MATA KULIAH	MAHASISWA/NIM	DOSEN PEMBIMBING	DOSEN PEMBIMBING	KETERANGAN
 <p>UNIVERSITAS SAM RATULANGI FAKULTAS TEKNIK JURUSAN ARSITEKTUR PRODI ARSITEKTUR</p>	DESAIN ARSITEKTUR V	<p>RINDA WULAN KALANGI (17021102011)</p>	<p>Ir. Octavianus H. A Rogi, ST, M.Si Dr.Valeria Woy, ST.,MT Prof. DR. Ir. Ar. Jefrev. I. Kindangen, DEA, IAI Cynthia E.V Wuisanq, ST,MUrbHabMgt, PhD DR. Ir. Reny Syafrini, M.Ars</p>	<p>Ir. Octavianus H. A Rogi, ST, M.Si</p>	
	JUDUL TUGAS				
	CAPITAL INVESTMENT MIXED USE				



SPOT RUANG DALAM RETAIL TOKO

	MATA KULIAH	MAHASISWA/NIM	DOSEN PEMBIMBING	DOSEN PEMBIMBING	KETERANGAN
 <p>UNIVERSITAS SAM RATULANGI FAKULTAS TEKNIK JURUSAN ARSITEKTUR PRODI ARSITEKTUR</p>	DESAIN ARSITEKTUR V	<p>RINDA WULAN KALANGI (17021102011)</p>	<p>Ir. Octavianus H. A Rogi, ST, M.Si Dr.Valeria Woy, ST.,MT Prof. DR. Ir. Ar. Jefrev. I. Kindangen, DEA, IAI Cynthia E.V Wuisanq, ST,MURbHabMgt, PhD DR. Ir. Reny Syafrini, M.Ars</p>	<p>Ir. Octavianus H. A Rogi, ST, M.Si</p>	
	JUDUL TUGAS				
	CAPITAL INVESTMENT MIXED USE				



SPOT RUANG DALAM RENTAL OFFICE TIPE C

	MATA KULIAH	MAHASISWA/NIM	DOSEN PEMBIMBING	DOSEN PEMBIMBING	KETERANGAN
 <p>UNIVERSITAS SAM RATULANGI FAKULTAS TEKNIK JURUSAN ARSITEKTUR PRODI ARSITEKTUR</p>	DESAIN ARSITEKTUR V	<p>RINDA WULAN KALANGI (17021102011)</p>	<p>Ir. Octavianus H. A Rogi, ST, M.Si Dr.Valeria Woy, ST.,MT Prof. DR. Ir. Ar. Jefrev. I. Kindangen, DEA, IAI Cynthia E.V Wuisanq, ST,MUrbHabMgt, PhD DR. Ir. Reny Syafrini, M.Ars</p>	<p>Ir. Octavianus H. A Rogi, ST, M.Si</p>	
	JUDUL TUGAS				
	CAPITAL INVESTMENT MIXED USE				



SPOT RUANG DALAM MEETING ROOM

	MATA KULIAH	MAHASISWA/NIM	DOSEN PEMBIMBING	DOSEN PEMBIMBING	KETERANGAN
 <p>UNIVERSITAS SAM RATULANGI FAKULTAS TEKNIK JURUSAN ARSITEKTUR PRODI ARSITEKTUR</p>	DESAIN ARSITEKTUR V	<p>RINDA WULAN KALANGI (17021102011)</p>	<p>Ir. Octavianus H. A Rogi, ST, M.Si Dr.Valeria Woy, ST.,MT Prof. DR. Ir. Ar. Jefrev. I. Kindangen, DEA, IAI Cynthia E.V Wuisanq, ST,MUrbHabMgt, PhD DR. Ir. Reny Syafrini, M.Ars</p>	<p>Ir. Octavianus H. A Rogi, ST, M.Si</p>	
	JUDUL TUGAS				
	CAPITAL INVESTMENT MIXED USE				



KETERANGAN

1. SPOT RUANG LUAR PARKIRAN
2. SPOT RUANG LUAR TAMAN
3. SPOT RUANG LUAR FOOD TRUCK
4. SPOT RUANG LUAR ROOFTOP HOTEL



KEYPOINT

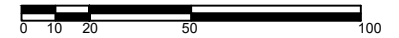

SCALE BAR 1:500

		MAHASISWA/NIM	DOSEN PEMBIMBING	DOSEN PEMBIMBING	KETERANGAN
 <p>UNIVERSITAS SAM RATULANGI FAKULTAS TEKNIK JURUSAN ARSITEKTUR PRODI ARSITEKTUR</p>	DESAIN ARSITEKTUR V	<p>RINDA WULAN KALANGI (17021102011)</p>	<p>Ir. Octavianus H. A Rogi, ST, M.Si Dr.Valeria Woy, ST.,MT Prof. DR. Ir. Ar. Jefrev. I. Kindangen, DEA, IAI Cynthia E.V Wuisanq, ST,MUrbHabMgt, PhD DR. Ir. Reny Syafrini, M.Ars</p>	<p>Ir. Octavianus H. A Rogi, ST, M.Si</p>	
	JUDUL TUGAS				
	CAPITAL INVESTMENT MIXED USE				



1 SPOT RUANG LUAR PARKING

	MATA KULIAH	MAHASISWA/NIM	DOSEN PEMBIMBING	DOSEN PEMBIMBING	KETERANGAN
 <p>UNIVERSITAS SAM RATULANGI FAKULTAS TEKNIK JURUSAN ARSITEKTUR PRODI ARSITEKTUR</p>	DESAIN ARSITEKTUR V	<p>RINDA WULAN KALANGI (17021102011)</p>	<p>Ir. Octavianus H. A Rogi, ST, M.Si Dr.Valeria Woy, ST.,MT Prof. DR. Ir. Ar. Jefrev. I. Kindangen, DEA, IAI Cynthia E.V Wuisanq, ST,MurbHabMgt, PhD DR. Ir. Reny Syafrini, M.Ars</p>	<p>Ir. Octavianus H. A Rogi, ST, M.Si</p>	
	JUDUL TUGAS				
	CAPITAL INVESTMENT MIXED USE				



2 SPOT RUANG LUAR TAMAN

	MATA KULIAH	MAHASISWA/NIM	DOSEN PEMBIMBING	DOSEN PEMBIMBING	KETERANGAN
 <p>UNIVERSITAS SAM RATULANGI FAKULTAS TEKNIK JURUSAN ARSITEKTUR PRODI ARSITEKTUR</p>	DESAIN ARSITEKTUR V	<p>RINDA WULAN KALANGI (17021102011)</p>	<p>Ir. Octavianus H. A Rogi, ST, M.Si Dr.Valeria Woy, ST.,MT Prof. DR. Ir. Ar. Jefrev. I. Kindangen, DEA, IAI Cynthia E.V Wuisanq, ST,MUrbHabMgt, PhD DR. Ir. Reny Syafrini, M.Ars</p>	<p>Ir. Octavianus H. A Rogi, ST, M.Si</p>	
	JUDUL TUGAS				
	CAPITAL INVESTMENT MIXED USE				



3 SPOT RUANG LUAR FOOD TRUCK

	MATA KULIAH	MAHASISWA/NIM	DOSEN PEMBIMBING	DOSEN PEMBIMBING	KETERANGAN
 <p>UNIVERSITAS SAM RATULANGI FAKULTAS TEKNIK JURUSAN ARSITEKTUR PRODI ARSITEKTUR</p>	DESAIN ARSITEKTUR V	<p>RINDA WULAN KALANGI (17021102011)</p>	<p>Ir. Octavianus H. A Rogi, ST, M.Si Dr.Valeria Woy, ST.,MT Prof. DR. Ir. Ar. Jefrev. I. Kindangen, DEA, IAI Cynthia E.V Wuisanq, ST,MURbHabMgt, PhD DR. Ir. Reny Syafrini, M.Ars</p>	<p>Ir. Octavianus H. A Rogi, ST, M.Si</p>	
	JUDUL TUGAS				
	CAPITAL INVESTMENT MIXED USE				



4

SPOT RUANG LUAR ROOFTOP HOTEL

	MATA KULIAH	MAHASISWA/NIM	DOSEN PEMBIMBING	DOSEN PEMBIMBING	KETERANGAN
 <p>UNIVERSITAS SAM RATULANGI FAKULTAS TEKNIK JURUSAN ARSITEKTUR PRODI ARSITEKTUR</p>	DESAIN ARSITEKTUR V	<p>RINDA WULAN KALANGI (17021102011)</p>	<p>Ir. Octavianus H. A Rogi, ST, M.Si Dr.Valeria Woy, ST.,MT Prof. DR. Ir. Ar. Jefrev. I. Kindangen, DEA, IAI Cynthia E.V Wuisanq, ST,MUrbHabMgt, PhD DR. Ir. Reny Syafrini, M.Ars</p>	<p>Ir. Octavianus H. A Rogi, ST, M.Si</p>	
	JUDUL TUGAS				
	CAPITAL INVESTMENT MIXED USE				

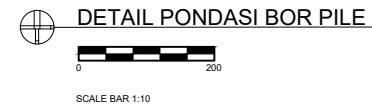
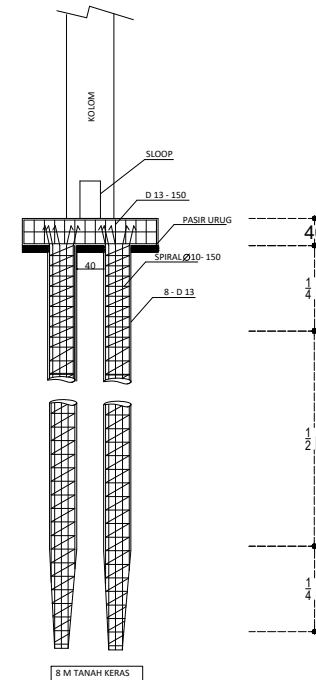
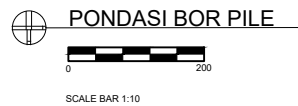
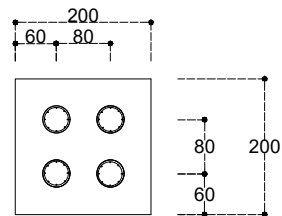
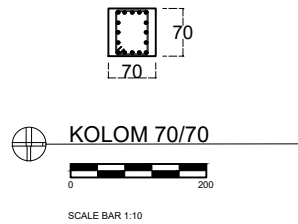

 UNIVERSITAS SAM RATULANGI FAKULTAS TEKNIK JURUSAN ARSITEKTUR PRODI ARSITEKTUR	MATA KULIAH	MAHASISWA/NIM	DOSEN PEMBIMBING	DOSEN PEMBIMBING	KETERANGAN
	DESAIN ARSITEKTUR V	RINDA WULAN KALANGI (17021102011)	Ir. Octavianus H. A Rogi, ST, M.Si Dr.Valeria Woy, ST.,MT Prof. DR. Ir. Ar. Jefrev. I. Kindangen, DEA, IAI Cynthia E.V Wuisanq, ST,MURbHabMgt, PhD DR. Ir. Reny Syafrini, M.Ars	Ir. Octavianus H. A Rogi, ST, M.Si	
	JUDUL TUGAS				
	CAPITAL INVESTMENT MIXED USE				

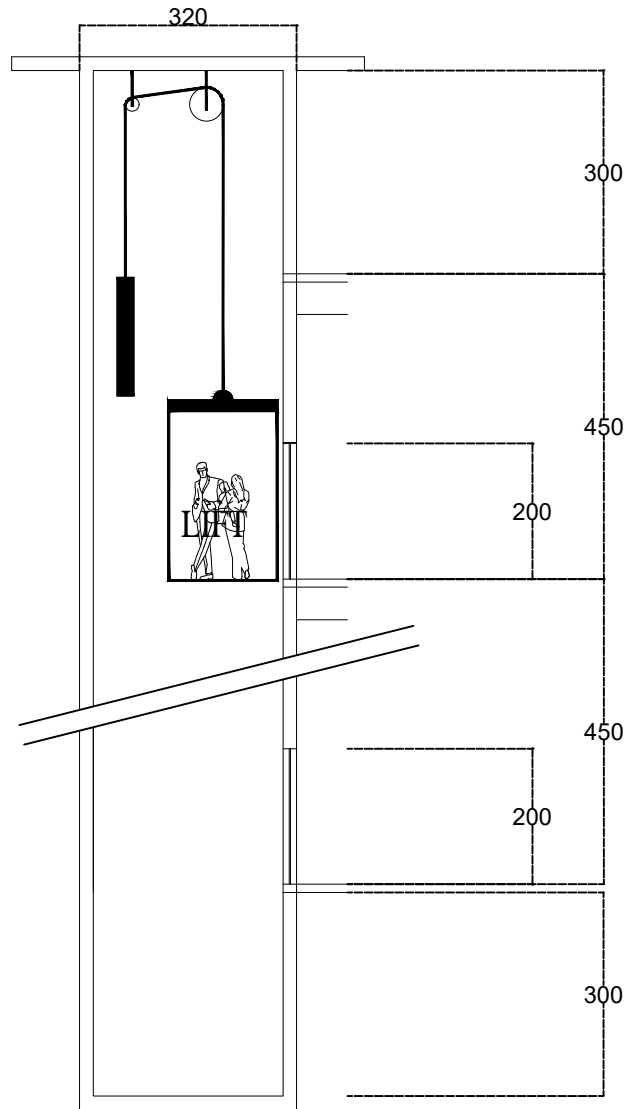

POTONGAN LIFT
SCALE BAR 1:10

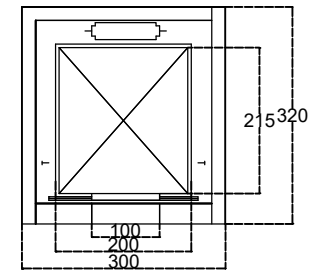

DETAIL LIFT
SCALE BAR 1:10

	MATA KULIAH	MAHASISWA/NIM	DOSEN PEMBIMBING	DOSEN PEMBIMBING	KETERANGAN
 <p>UNIVERSITAS SAM RATULANGI FAKULTAS TEKNIK JURUSAN ARSITEKTUR PRODI ARSITEKTUR</p>	DESAIN ARSITEKTUR V	<p>RINDA WULAN KALANGI (17021102011)</p>	<p>Ir. Octavianus H. A Rogi, ST, M.Si Dr.Valeria Woy, ST.,MT Prof. DR. Ir. Ar. Jefrev. I. Kindangan, DEA, IAI Cynthia E.V Wuisanq, ST,MUrbHabMgt, PhD DR. Ir. Reny Syafrini, M.Ars</p>	<p>Ir. Octavianus H. A Rogi, ST, M.Si</p>	
	JUDUL TUGAS				
	CAPITAL INVESTMENT MIXED USE				

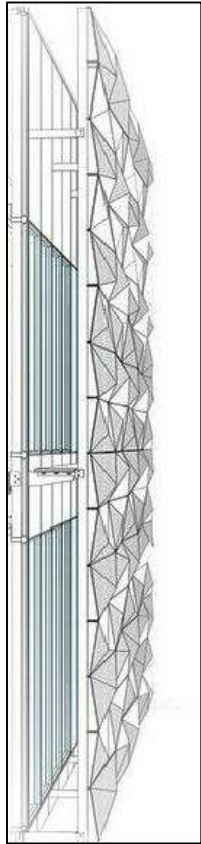

⊕ DETAIL FASAD



⊕ TAMPAK DETAIL FASAD

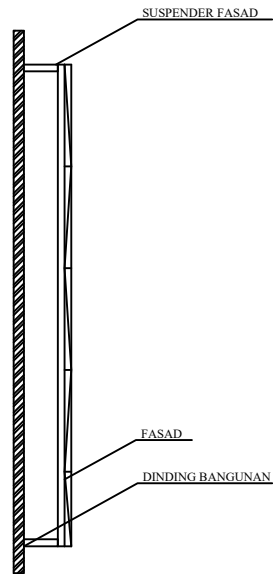

⊕ POTONGAN DETAIL FASAD
SCALE BAR 1:10



⊕ TAMPAK DETAIL FASAD

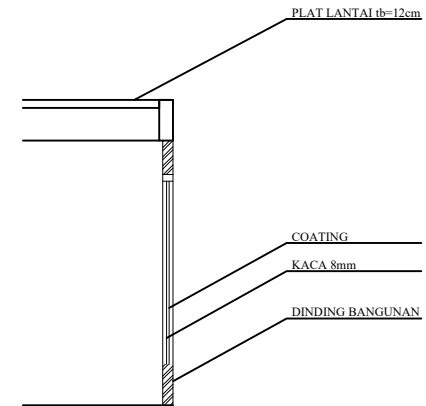

⊕ POTONGAN DETAIL FASAD
SCALE BAR 1:10



UNIVERSITAS SAM RATULANGI
FAKULTAS TEKNIK
JURUSAN ARSITEKTUR
PRODI ARSITEKTUR

MATA KULIAH	MAHASISWA/NIM	DOSEN PEMBIMBING	DOSEN PEMBIMBING	KETERANGAN
DESAIN ARSITEKTUR V	RINDA WULAN KALANGI (17021102011)	Ir. Octavianus H. A Rogi, ST, M.Si Dr.Valeria Woy, ST.,MT Prof. DR. Ir. Ar. Jefrev. I. Kindangen, DEA, IAI Cynthia E.V Wuisanq, ST,MurbHabMgt, PhD DR. Ir. Reny Syafrini, M.Ars	Ir. Octavianus H. A Rogi, ST, M.Si	
JUDUL TUGAS				
CAPITAL INVESTMENT MIXED USE				